

7008-F-08-08-SS

Stainless Steel, SAE J514 37° Flare Female JIS Adapter, 1/2" Male JIC x 1/2-14 Female JIS

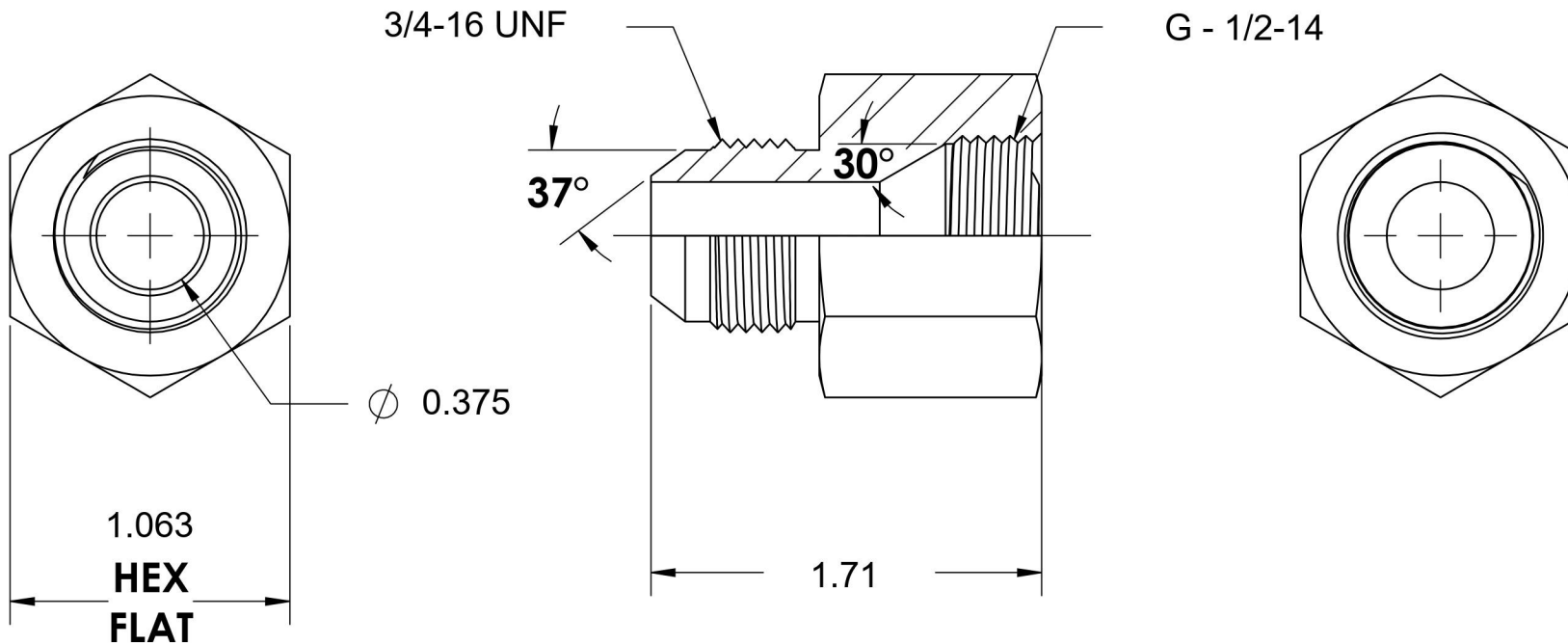
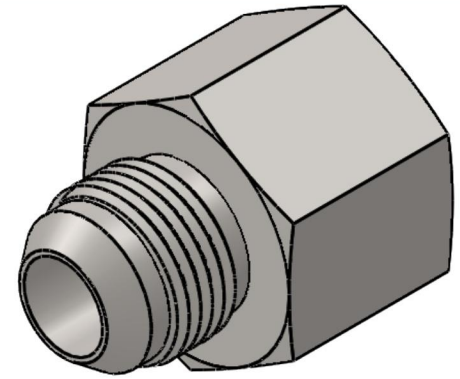

6701 Cochran Road
Solon, Ohio 44139
Phone: (440) 248-1880
Toll Free: 1-888-331-1523

Temperature Rating	Material	Industry Standards	Series
-425°F to 1200°F	316/316L Stainless Steel	SAE J514, JIS B 0202	7008-F-SS
Pressure Rating	Finish		Series Description
5000 psi	Passivated		SAE J514 37° Flare Female JIS Adapter