

6402-32-32-O

Steel, SAE J514 37° Flare Swivel Port Connector, 2-1/2-12 Male ORB x 2" Female JIC Swivel

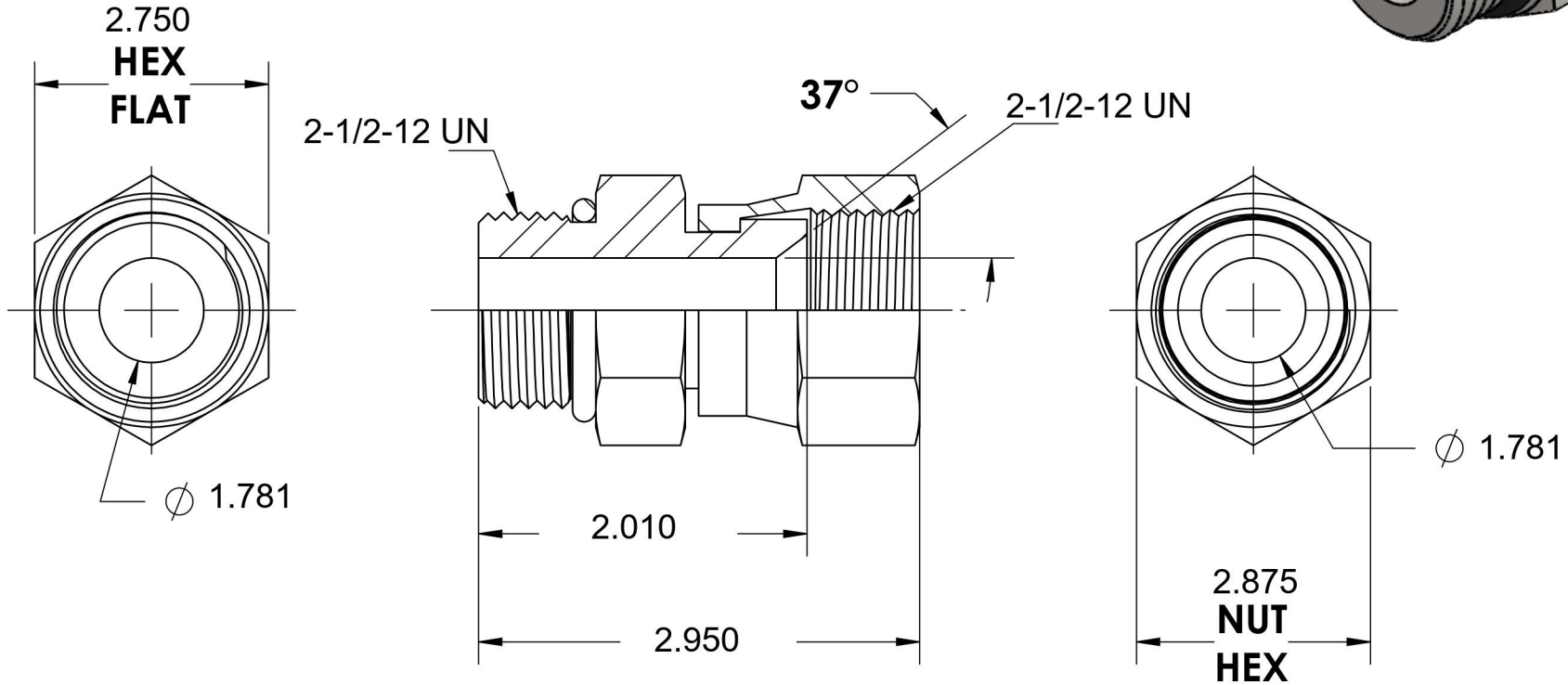
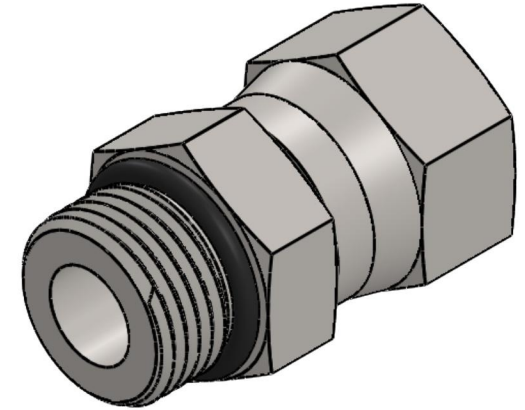

6701 Cochran Road
Solon, Ohio 44139
Phone: (440) 248-1880
Toll Free: 1-888-331-1523

Temperature Rating

-40°F to 250°F

Pressure Rating

2000 psi

Material

C1045 / 12L14 Steel

Finish

Trivalent Zinc

Industry Standards

SAE J514, SAE J1926-3
ASTM B633

Series

6402-O

Series Description

SAE J514 37° Flare Swivel
Port Connector