

9022-32-16

Steel, ISO 1179 BSPP Port/Line Union, 2-11 Male BSPP 60° Line/Port x 1-11 Male BSPP 60° Line/Port

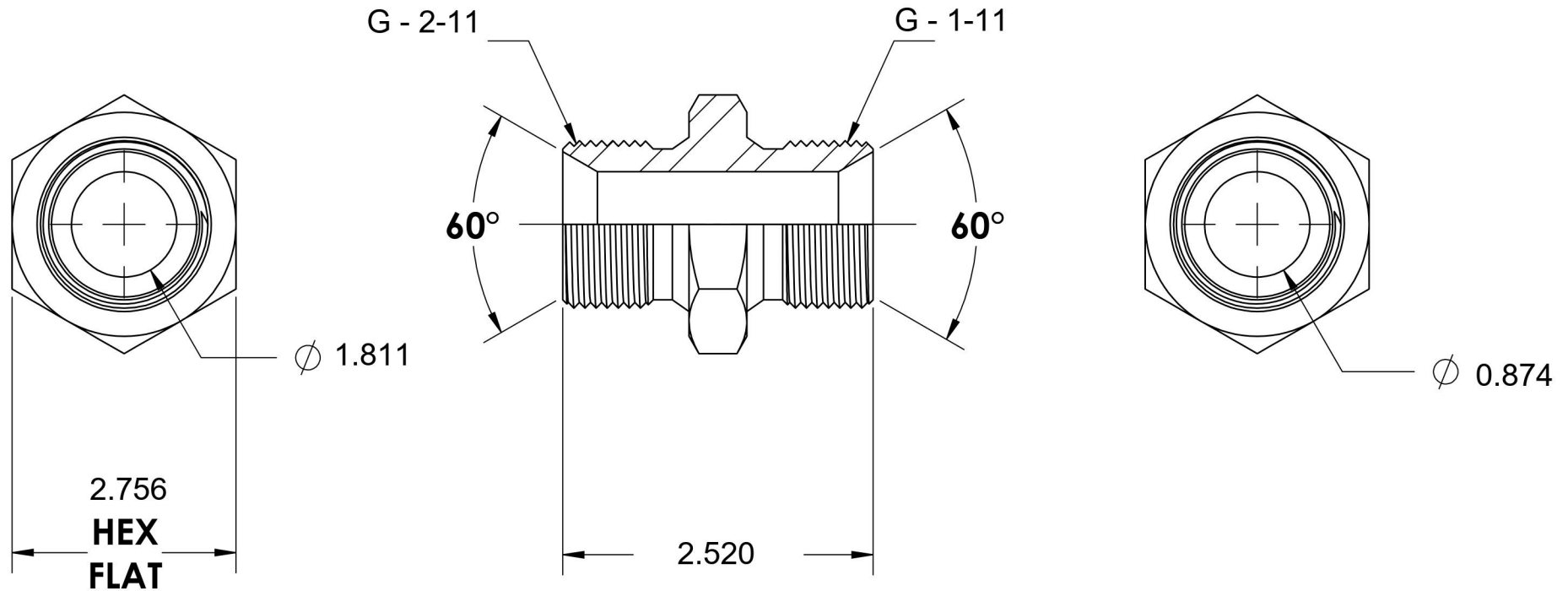
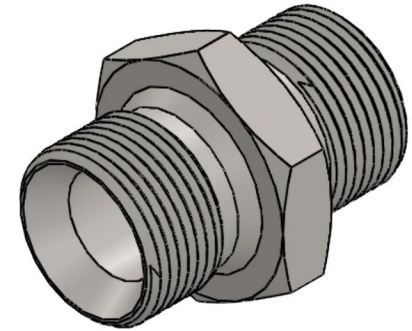

6701 Cochran Road
Solon, Ohio 44139
Phone: (440) 248-1880
Toll Free: 1-888-331-1523

Temperature Rating	Material	Industry Standards	Series
-65°F to 500°F	C1045/12L14 Steel	ISO 1179, ISO 8434-6 ASTM B633	9022
Pressure Rating	Finish		Series Description
1000 psi	Trivalent Zinc		ISO 1179 BSPP Port/Line Union