

2700-04-06

Steel, SAE J514 37° Flare Bulkhead, 1/4" Male JIC x 3/8" Male JIC

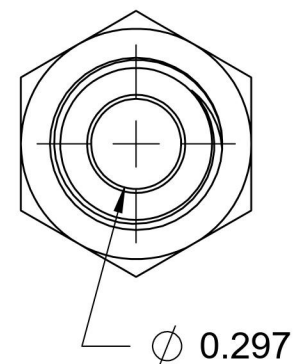
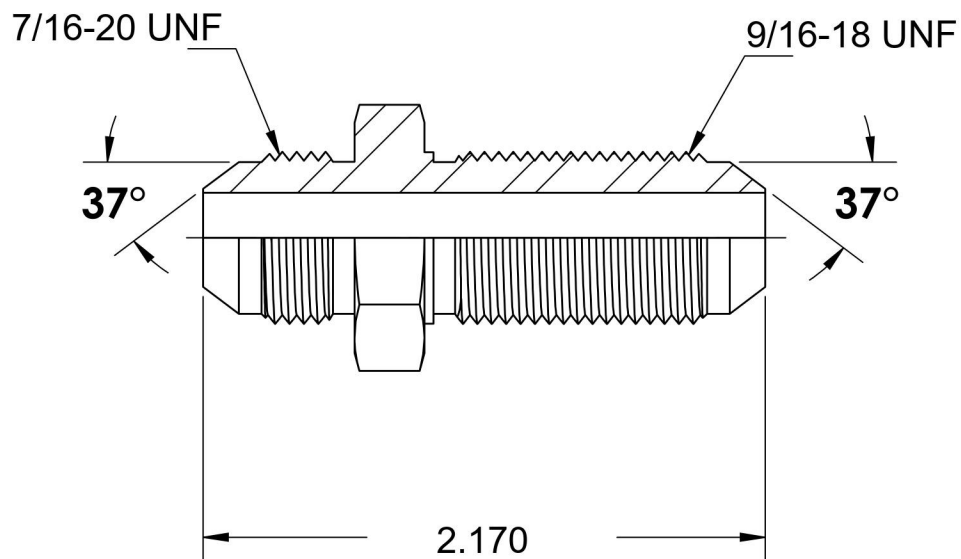
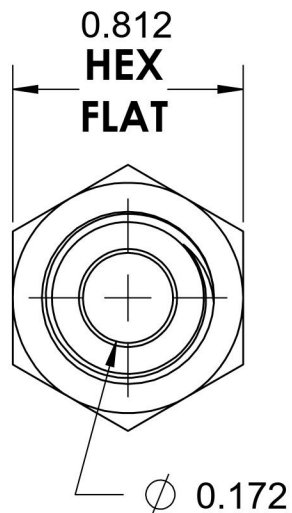
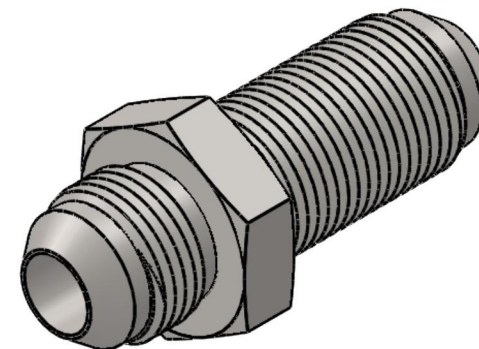

6701 Cochran Road
Solon, Ohio 44139
Phone: (440) 248-1880
Toll Free: 1-888-331-1523

Temperature Rating -65°F to 500°F	Material C1045/12L14 Steel	Industry Standards SAE J514, ASTM B633	Series 2700
Pressure Rating 6000 psi	Finish Trivalent Zinc		Series Description SAE J514 37° Flare Bulkhead