

6400-32-32-O-VITON

Steel, SAE J514 37° Flare Port Connector, 2" Male JIC x 2-1/2-12 Male ORB, FKM Seal

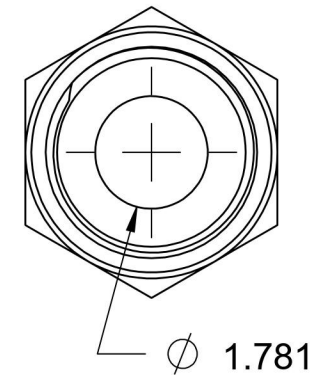
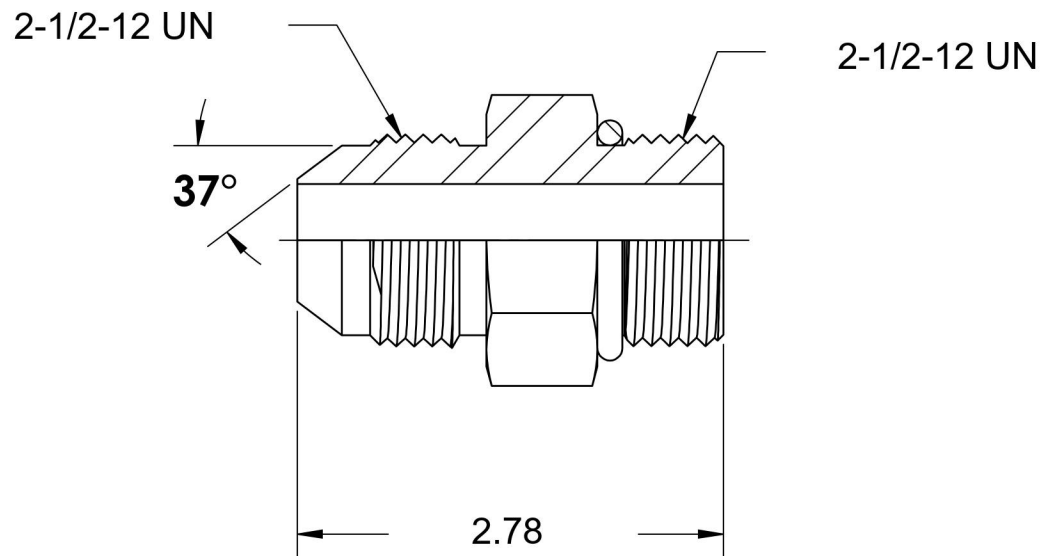
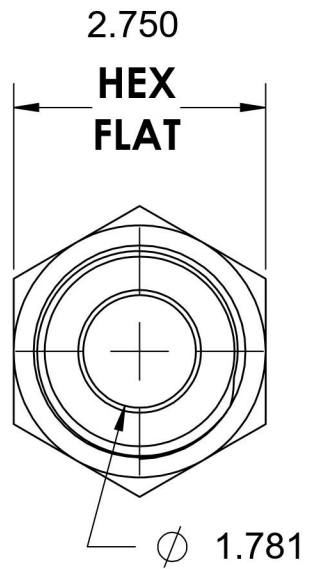

6701 Cochran Road
Solon, Ohio 44139
Phone: (440) 248-1880
Toll Free: 1-888-331-1523

Temperature Rating	Material	Industry Standards	Series
-15°F to 400°F	C1045 / 12L14 Steel	SAE J514, SAE J1926-3 ASTM B633	6400-O-VITON
Pressure Rating	Finish		Series Description
2000 psi	Trivalent Zinc		SAE J514 37° Flare Port Connector