

# FS6602-06-06-04-FG

Steel, SAE J1453 O-Ring Face Seal Swivel Run Tee, 3/8" Male ORFS x 3/8" Female ORFS Swivel x 1/4" Male ORFS

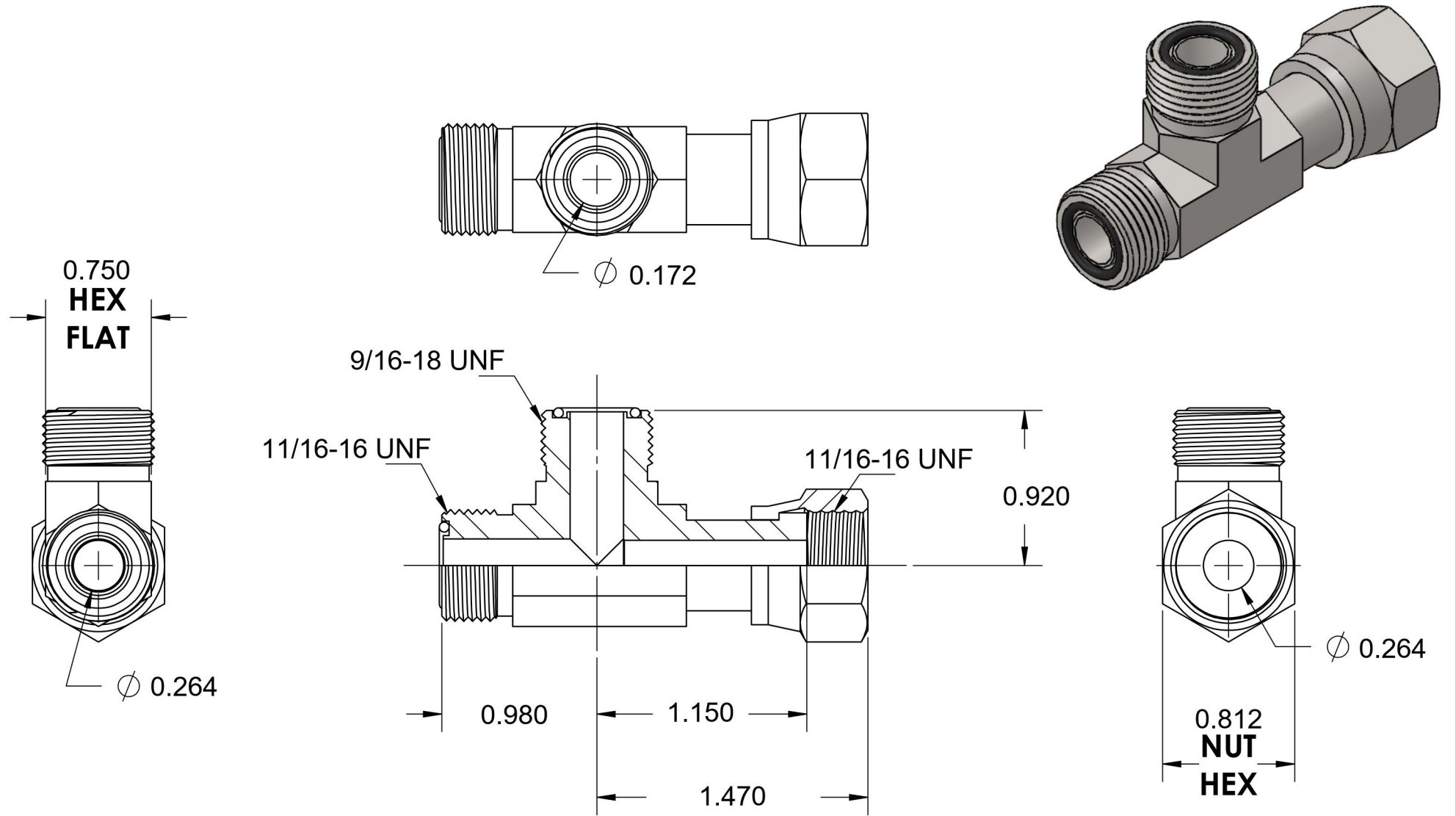

6701 Cochran Road  
Solon, Ohio 44139  
Phone: (440) 248-1880  
Toll Free: 1-888-331-1523

**Temperature Rating**

-40°F to 250°F

**Pressure Rating**

9200 psi

**Material**

C1045 Steel

**Finish**

Trivalent Zinc

**Industry Standards**

SAE J1453, SAE J515  
ASTM B633

**Series**

FS6602-FG

**Series Description**

SAE J1453 O-Ring Face Seal  
Swivel Run Tee