

1503-06-08-FG

Steel, SAE J514 NPSM Swivel 45° Male Elbow, 3/8" Male NPTF 30° x 1/2" Female NPSM Swivel

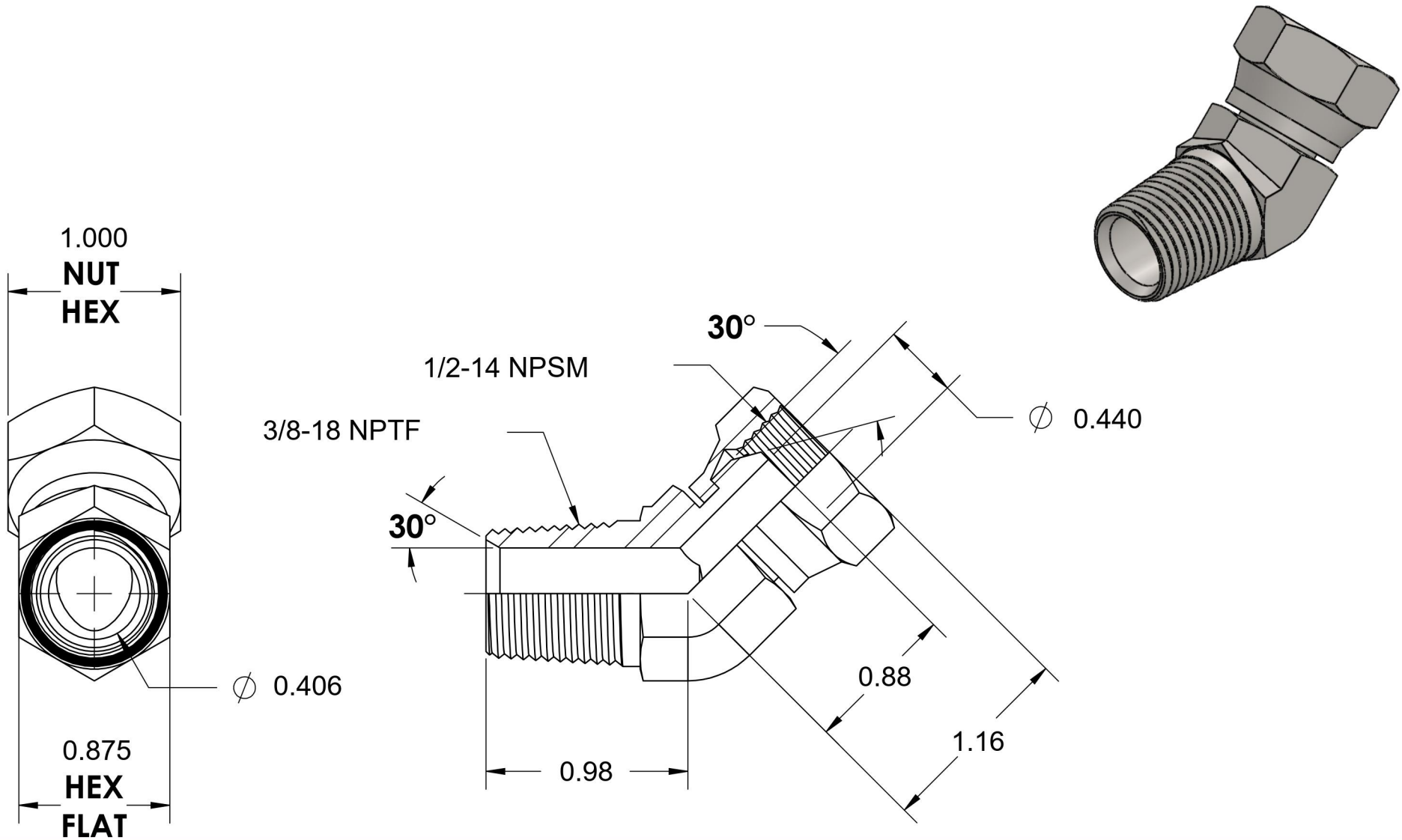

6701 Cochran Road
Solon, Ohio 44139
Phone: (440) 248-1880
Toll Free: 1-888-331-1523

Temperature Rating	-65°F to 500°F	Material	C1045 Steel	Industry Standards	SAE J514, SAE J476 ASTM B633	Series	1503-FG
Pressure Rating	5000 psi	Finish	Trivalent Zinc			Series Description	SAE J514 NPSM Swivel 45° Male Elbow