

D0304-C-L42

Steel, DIN 2353 Blanking Plug, Light 42mm Tube OD

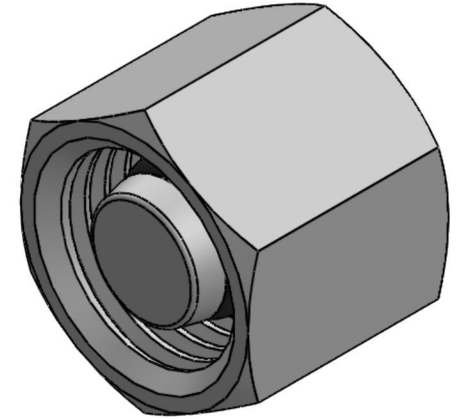
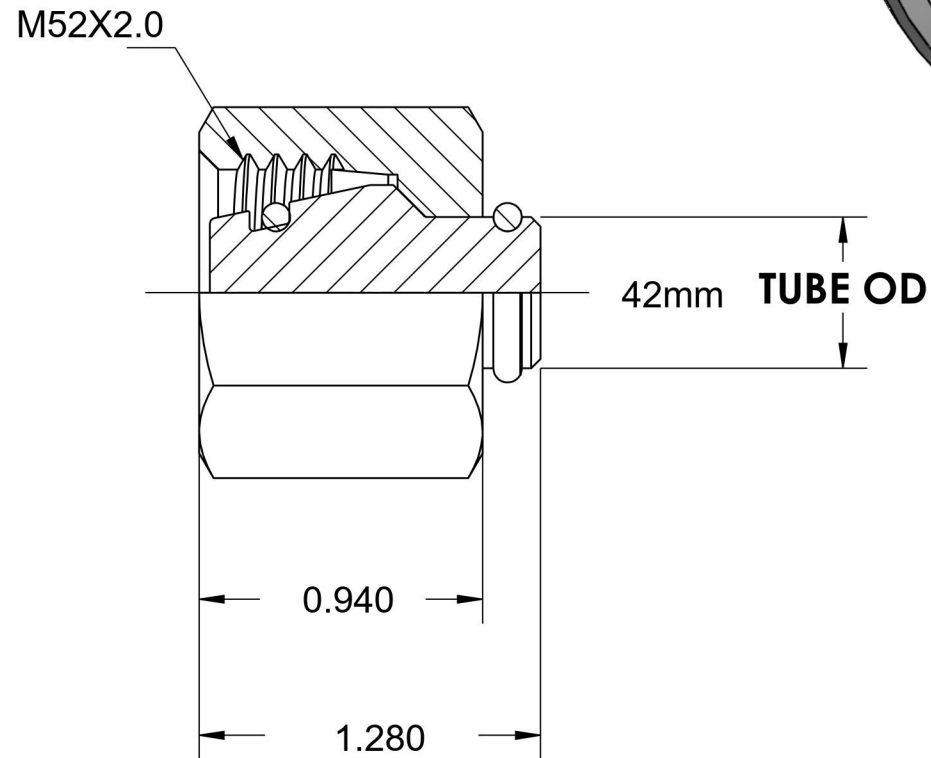
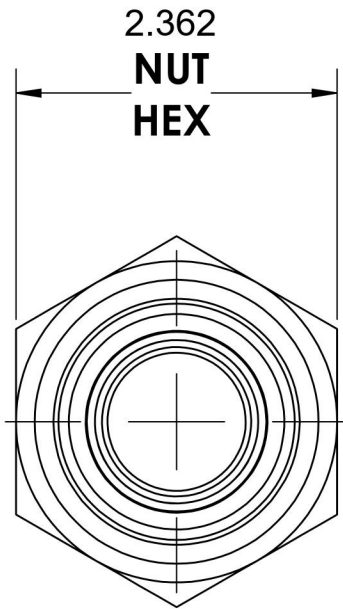

6701 Cochran Road
Solon, Ohio 44139
Phone: (440) 248-1880
Toll Free: 1-888-331-1523

Temperature Rating

-40°F to 250°F

Pressure Rating

Not Available

Material

C22 Steel

Finish

Zinc Nickel

Industry Standards

DIN 2353, ISO 8434-1

Series

D0304-C

Series Description

DIN 2353 Flareless Tube
Blanking Cap Assembly