

6400-04-12-O-SS

Stainless Steel, SAE J514 37° Flare Port Connector, 1/4" Male JIC x 1-1/16-12 Male ORB

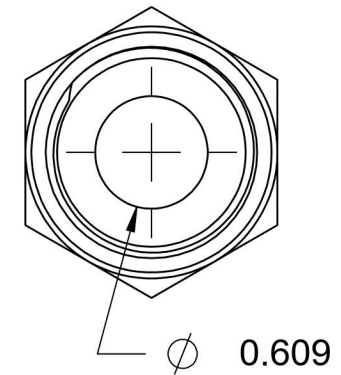
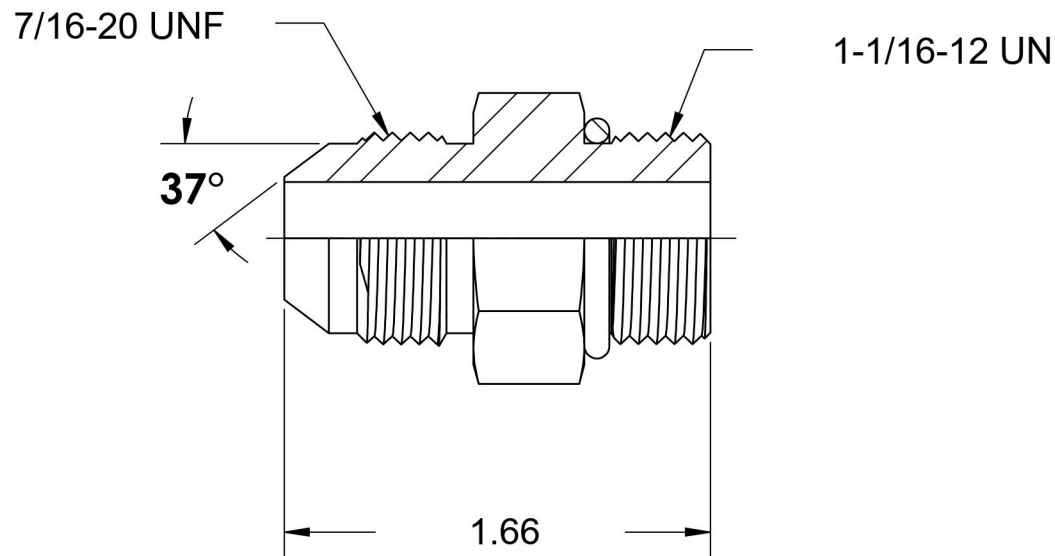
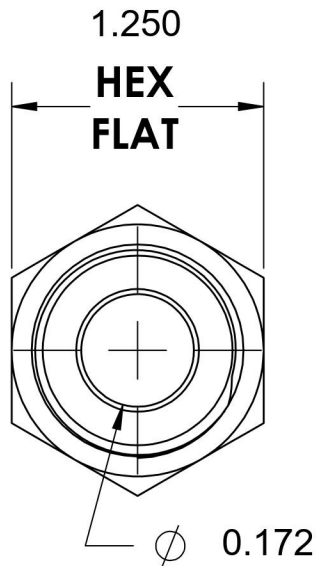

6701 Cochran Road
Solon, Ohio 44139
Phone: (440) 248-1880
Toll Free: 1-888-331-1523

Temperature Rating	Material	Industry Standards	Series
-40°F to 250°F	316/316L Stainless Steel	SAE J514, SAE J1926-3	6400-O-SS
Pressure Rating	Finish		Series Description
6000 psi	Passivated		SAE J514 37° Flare Port Connector