

6410-06-10-O

Steel, SAE J1926 O-Ring Boss Reducer, 9/16-18 Male ORB x 7/8-14 Female ORB

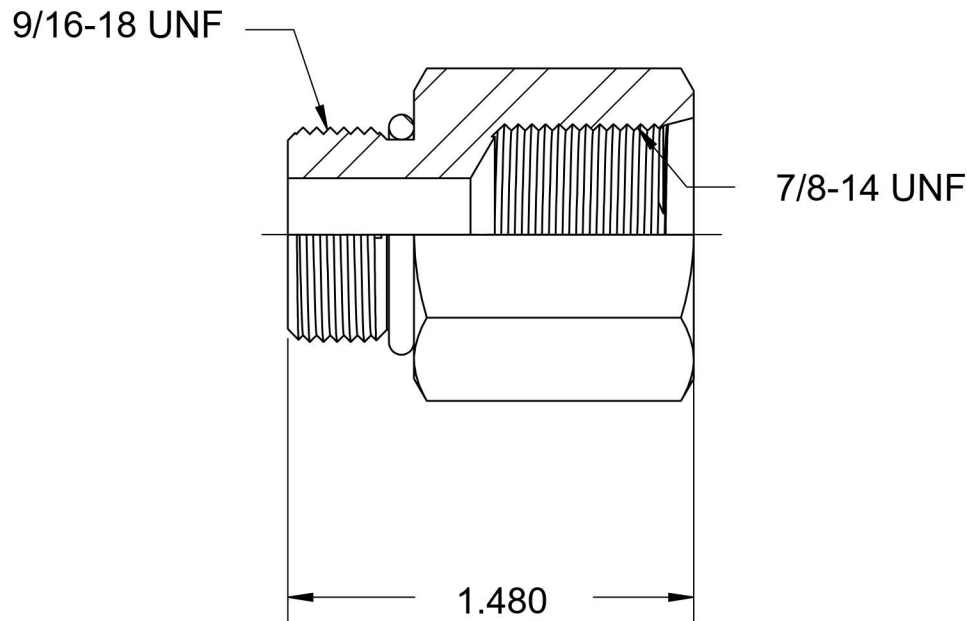
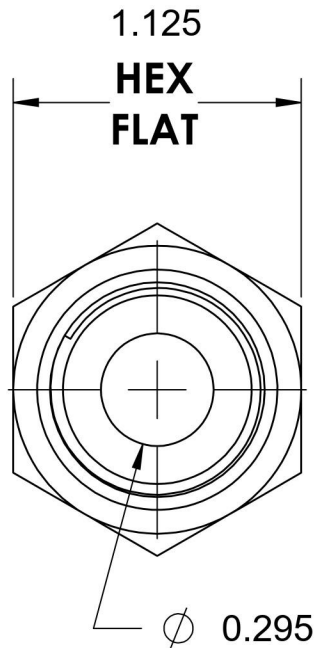

6701 Cochran Road
Solon, Ohio 44139
Phone: (440) 248-1880
Toll Free: 1-888-331-1523

Temperature Rating	Material	Industry Standards	Series
-40°F to 250°F	C1045 / 12L14 Steel	SAE J1926-3, SAE J515 ASTM B633	6410-O
Pressure Rating	Finish		Series Description
4500 psi	Trivalent Zinc		SAE J1926 O-Ring Boss Reducer