

2503-06-06-B

Brass, SAE J514 37° Flare 45° Male Elbow, 3/8" Male JIC x 3/8" Male NPTF 30°

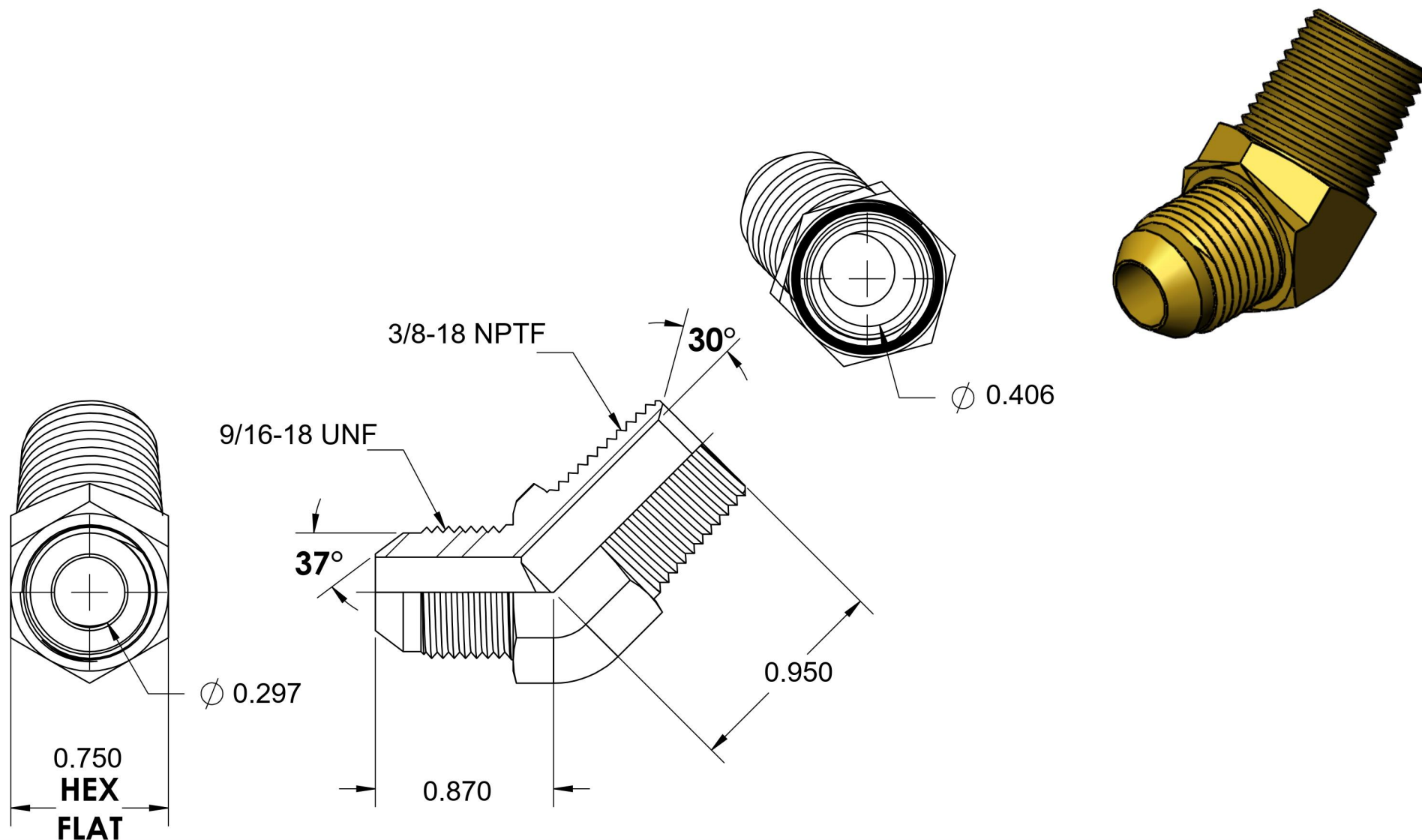

6701 Cochran Road
Solon, Ohio 44139
Phone: (440) 248-1880
Toll Free: 1-888-331-1523

Temperature Rating -325°F to 400°F	Material CA37700 Brass	Industry Standards SAE J514 , SAE J476	Series 2503-B
Pressure Rating 3300 psi	Finish Natural Finish		Series Description SAE J514 37° Flare 45° Male Elbow