

7003-08-12

Steel, SAE J514 37° Flare Female BSPP Port Adapter, 1/2" Male JIC x 3/4-14 Female BSPP

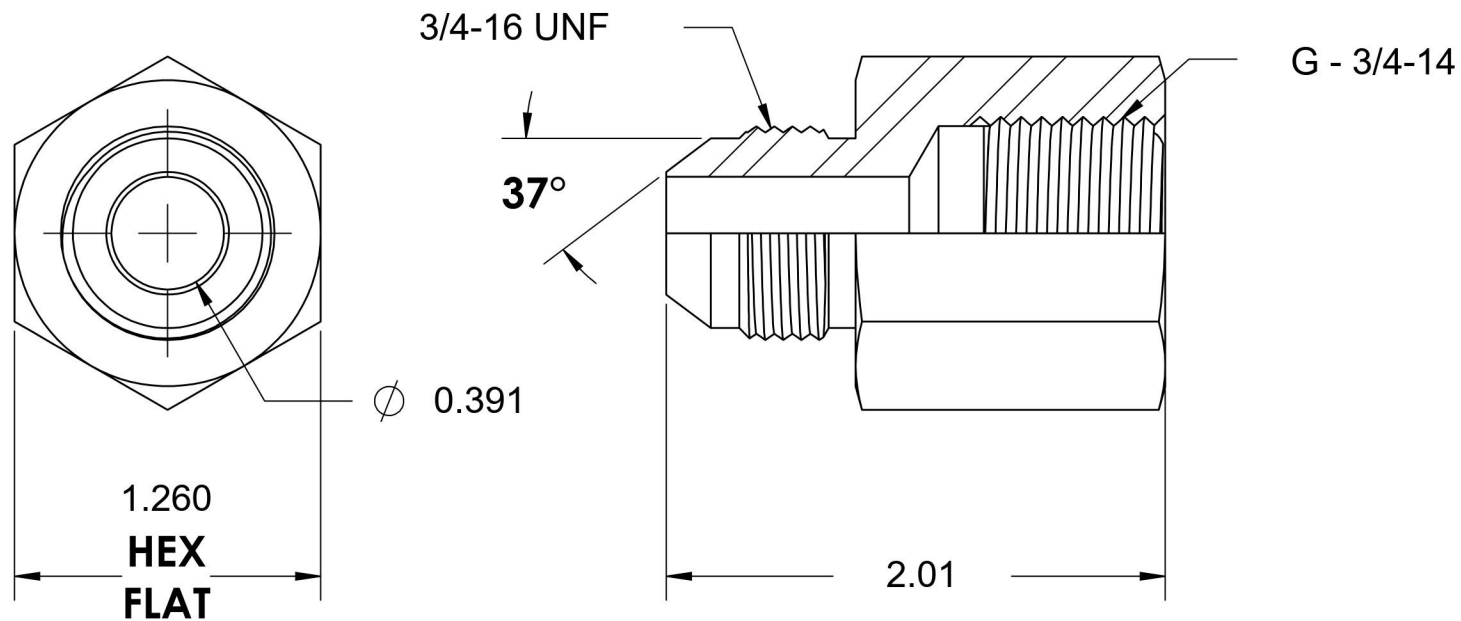
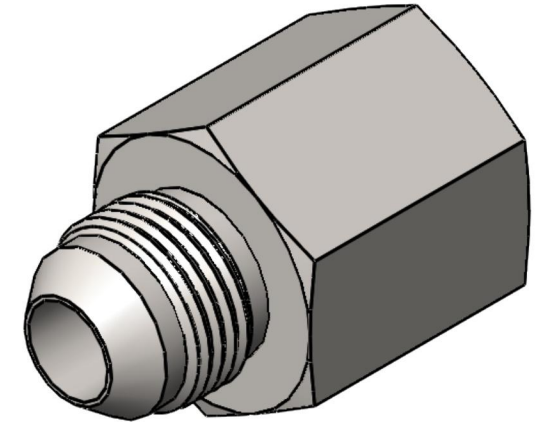

6701 Cochran Road
Solon, Ohio 44139
Phone: (440) 248-1880
Toll Free: 1-888-331-1523

Temperature Rating

-65°F to 500°F

Material

C1045/12L14 Steel

Industry Standards

SAE J514, ISO 1179

ASTM B633

Series

7003

Series Description

SAE J514 37° Flare
Female BSPP Port Adapter

Pressure Rating

4500 psi

Finish

Trivalent Zinc