

5500-08-08-B

Brass, SAE J514 Pipe 90° Male Elbow, 1/2" Male NPTF 30° x 1/2" Male NPTF 30°

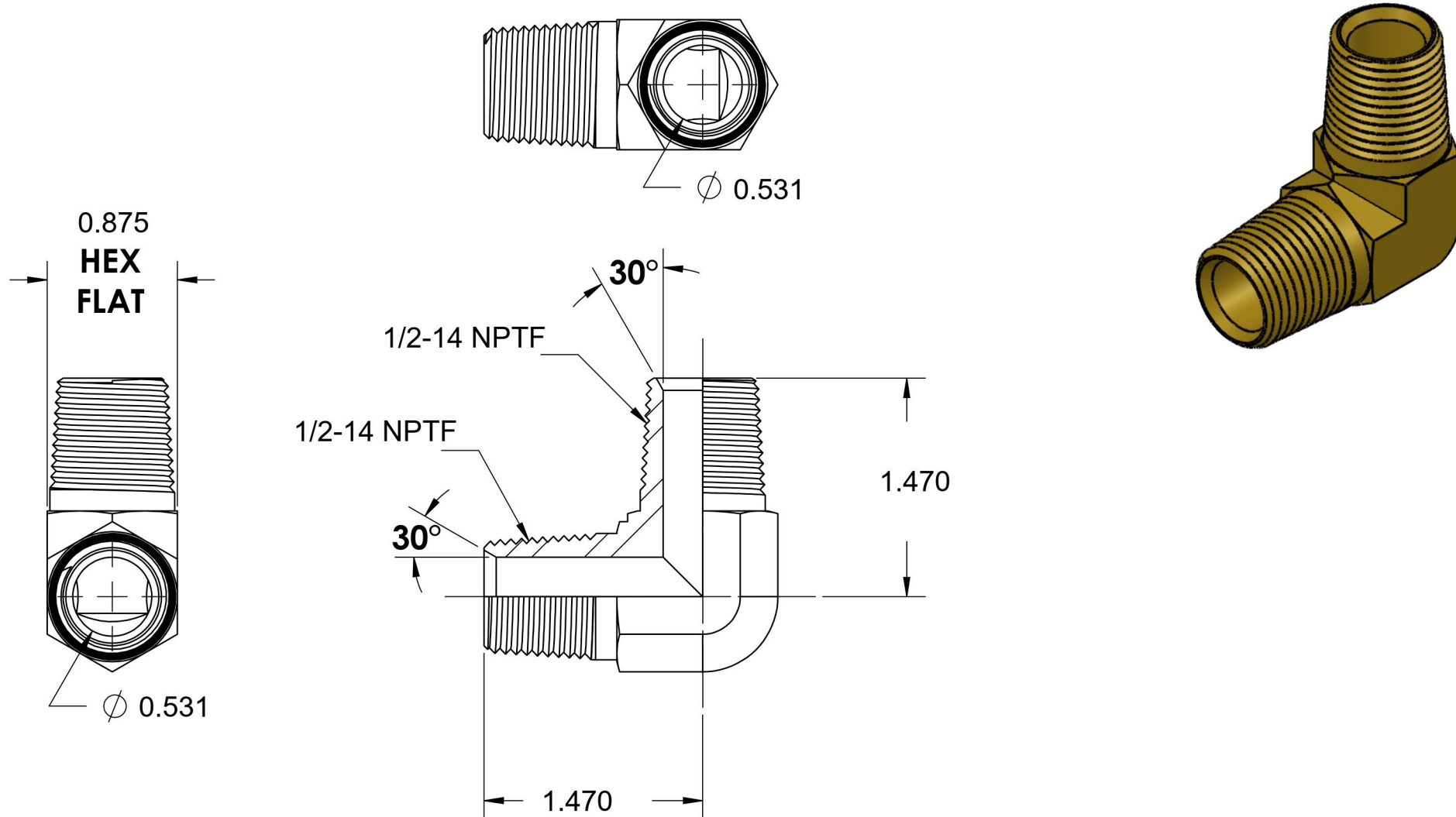

6701 Cochran Road
Solon, Ohio 44139
Phone: (440) 248-1880
Toll Free: 1-888-331-1523

Temperature Rating	Material	Industry Standards	Series
-325°F to 400°F	CA37700 Brass	SAE J514 , SAE J476	5500-B
Pressure Rating	Finish		Series Description
3900 psi	Natural Finish		SAE J514 Pipe 90° Male Elbow