

2501-06-04-B

Brass, SAE J514 37° Flare 90° Male Elbow, 3/8" Male JIC x 1/4" Male NPTF 30°

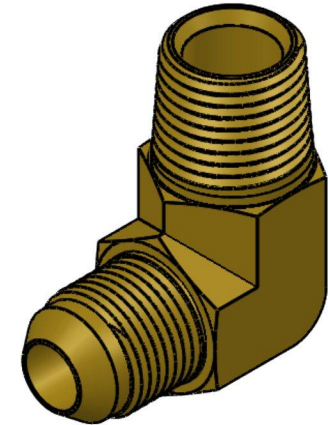
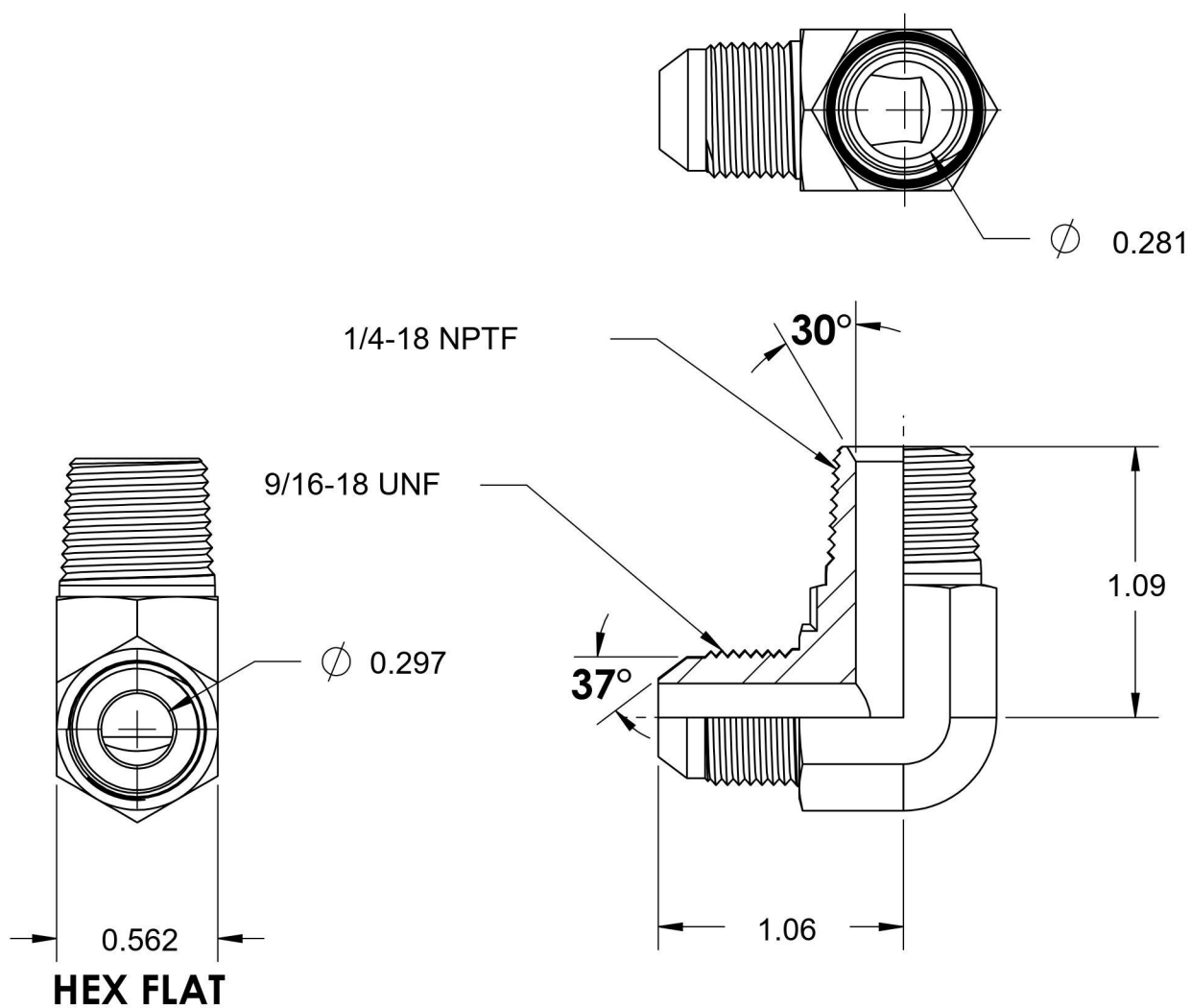

6701 Cochran Road
Solon, Ohio 44139
Phone: (440) 248-1880
Toll Free: 1-888-331-1523

Temperature Rating

-325°F to 400°F

Pressure Rating

3300 psi

Material

CA377 Brass

Finish

Natural Finish

Industry Standards

SAE J514, SAE J476

Series

2501-B

Series Description

SAE J514 37° Flare 90° Male Elbow