

6801-06-04-NWO-FG

Steel, SAE J514 37° Flare 90° Adjustable Port Elbow, 3/8" Male JIC x 7/16-20 Male Adjustable ORB

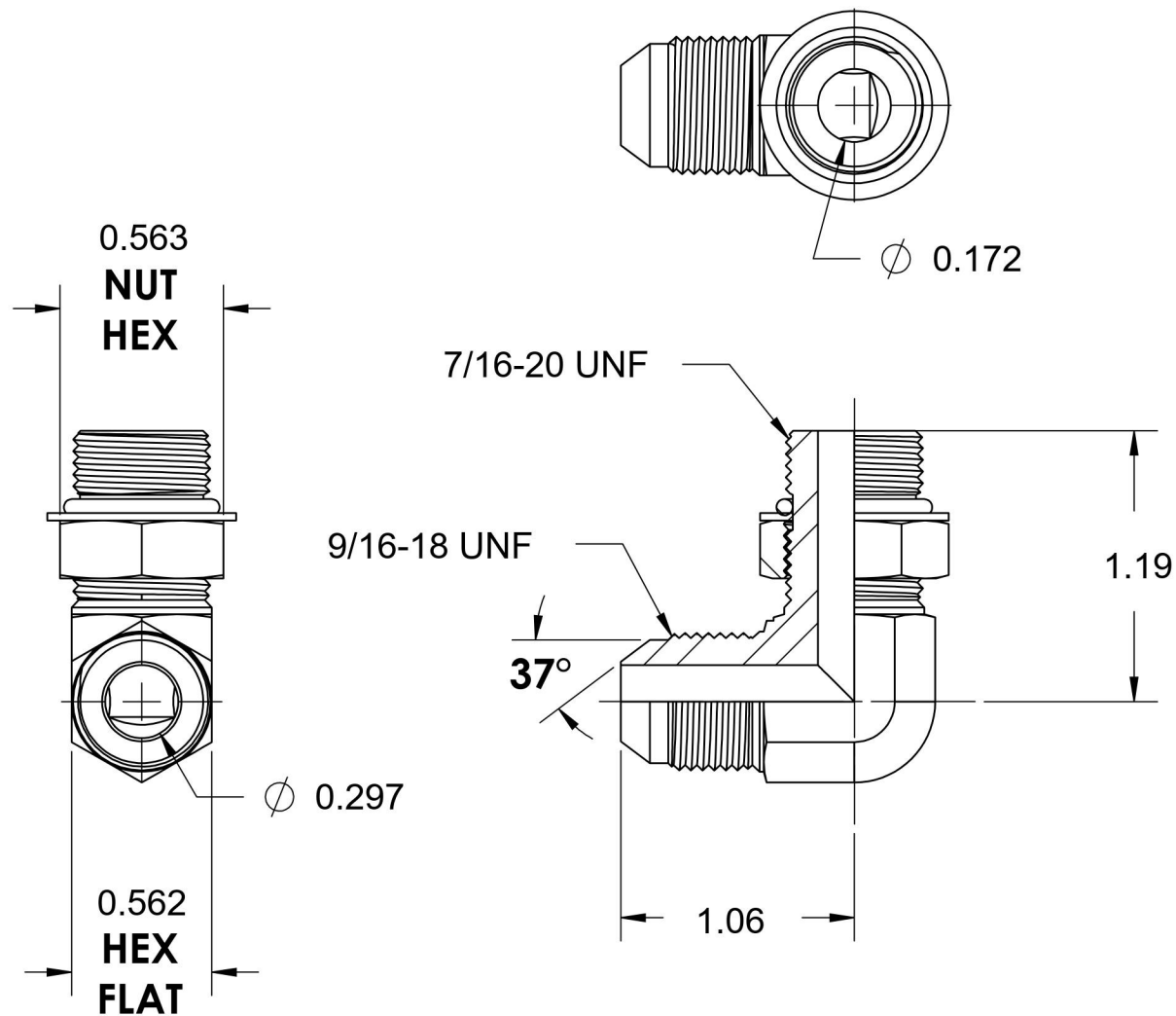

6701 Cochran Road
Solon, Ohio 44139
Phone: (440) 248-1880
Toll Free: 1-888-331-1523

Temperature Rating
-40°F / 250°F

Pressure Rating
6000 psi

Material
C1045 Steel

Finish
Trivalent Zinc

Industry Standards
SAE J514, SAE J1926-3
ASTM B633

Series
6801-NWO-FG

Series Description
SAE J514 37° Flare 90°
Adjustable Port Elbow