

# 6400-06-08-O-VITON

Steel, SAE J514 37° Flare Port Connector, 3/8" Male JIC x 3/4-16 Male ORB, FKM Seal

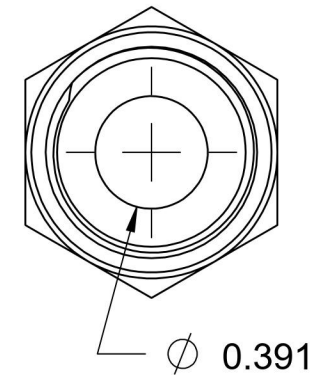
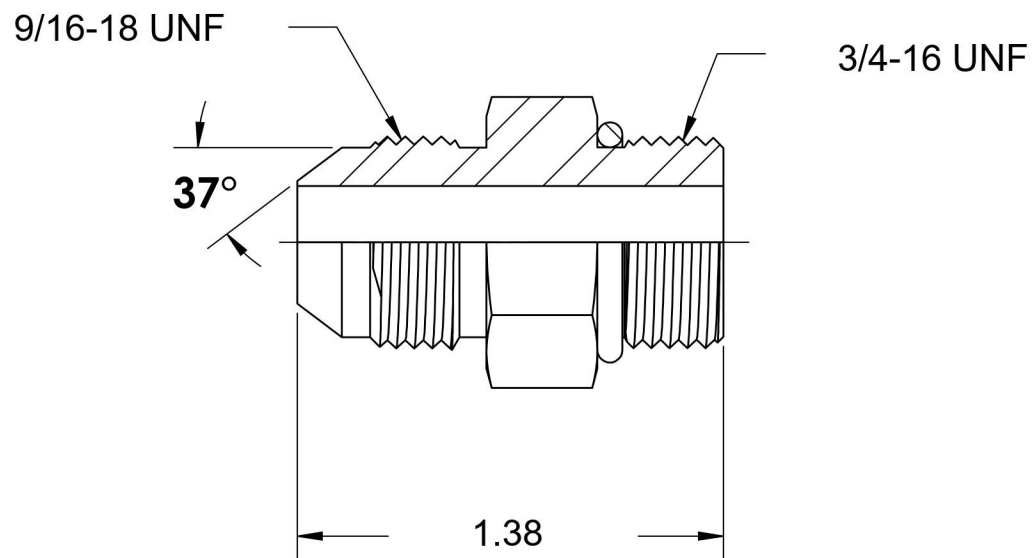
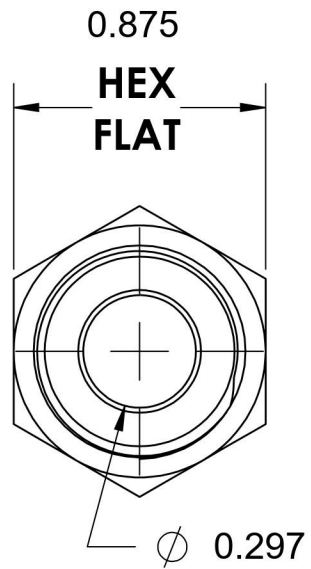

6701 Cochran Road  
Solon, Ohio 44139  
Phone: (440) 248-1880  
Toll Free: 1-888-331-1523

<b>Temperature Rating</b>	<b>Material</b>	<b>Industry Standards</b>	<b>Series</b>
-15°F to 400°F	C1045 / 12L14 Steel	SAE J514, SAE J1926-3	6400-O-VITON
<b>Pressure Rating</b>	<b>Finish</b>	ASTM B633	<b>Series Description</b>
6000 psi	Trivalent Zinc		SAE J514 37° Flare Port Connector