

7007-10-L12-18-SS

Stainless Steel, SAE J514 37° Flare DIN (L) Swivel Adapter, 5/8" Male JIC x M18X1.5 Female DKO Swivel

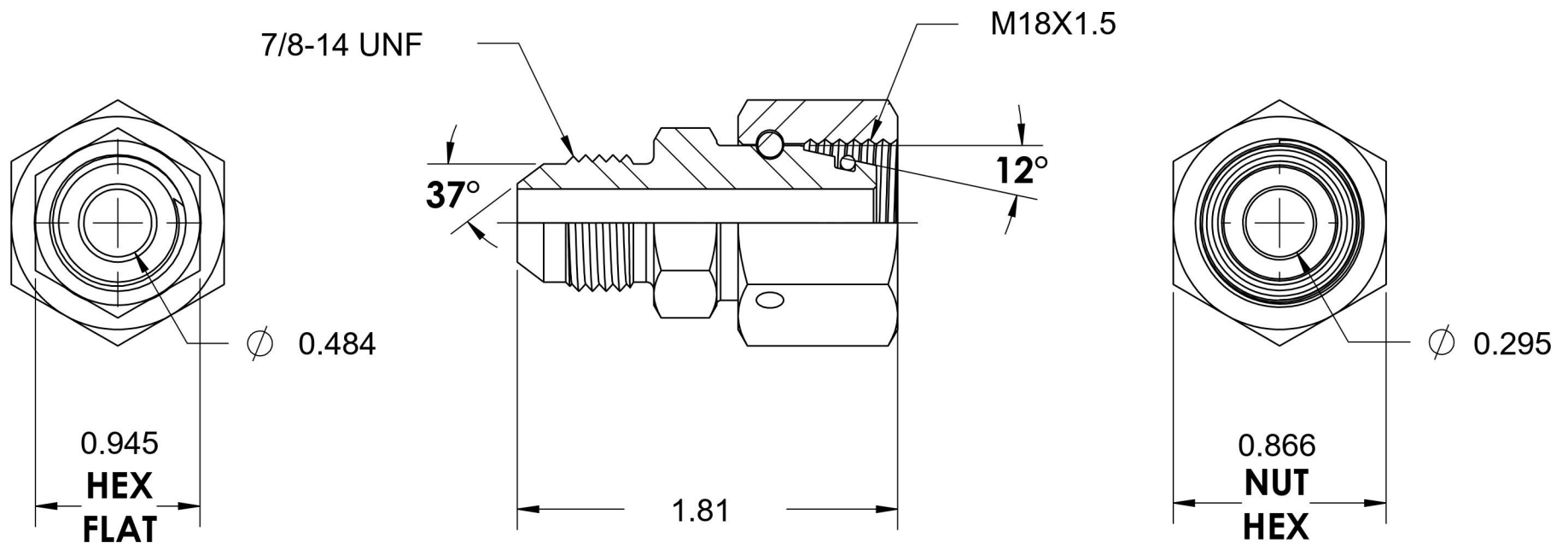

6701 Cochran Road
Solon, Ohio 44139
Phone: (440) 248-1880
Toll Free: 1-888-331-1523

Temperature Rating	Material	Industry Standards	Series
-40°F to 250°F	316/316L Stainless Steel	SAE J514, ISO 8434-1	7007-DIN LIGHT-SS
Pressure Rating	Finish	DIN 2353	Series Description
4500 psi	Passivated		SAE J514 37° Flare DIN (L) Swivel Adapter