

6809-08-06-NWO-FG

Steel, SAE J514 37° Flare Swivel 90° Adjustable Port Elbow, 3/4-16 Male Adjustable ORB x 3/8" Female JIC Swivel

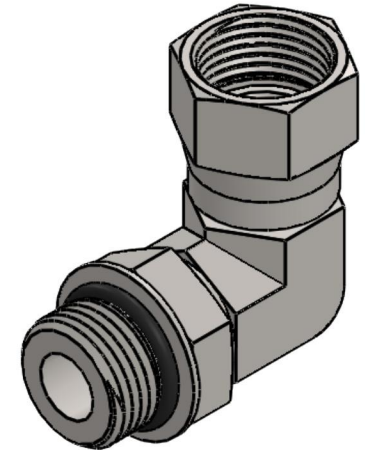
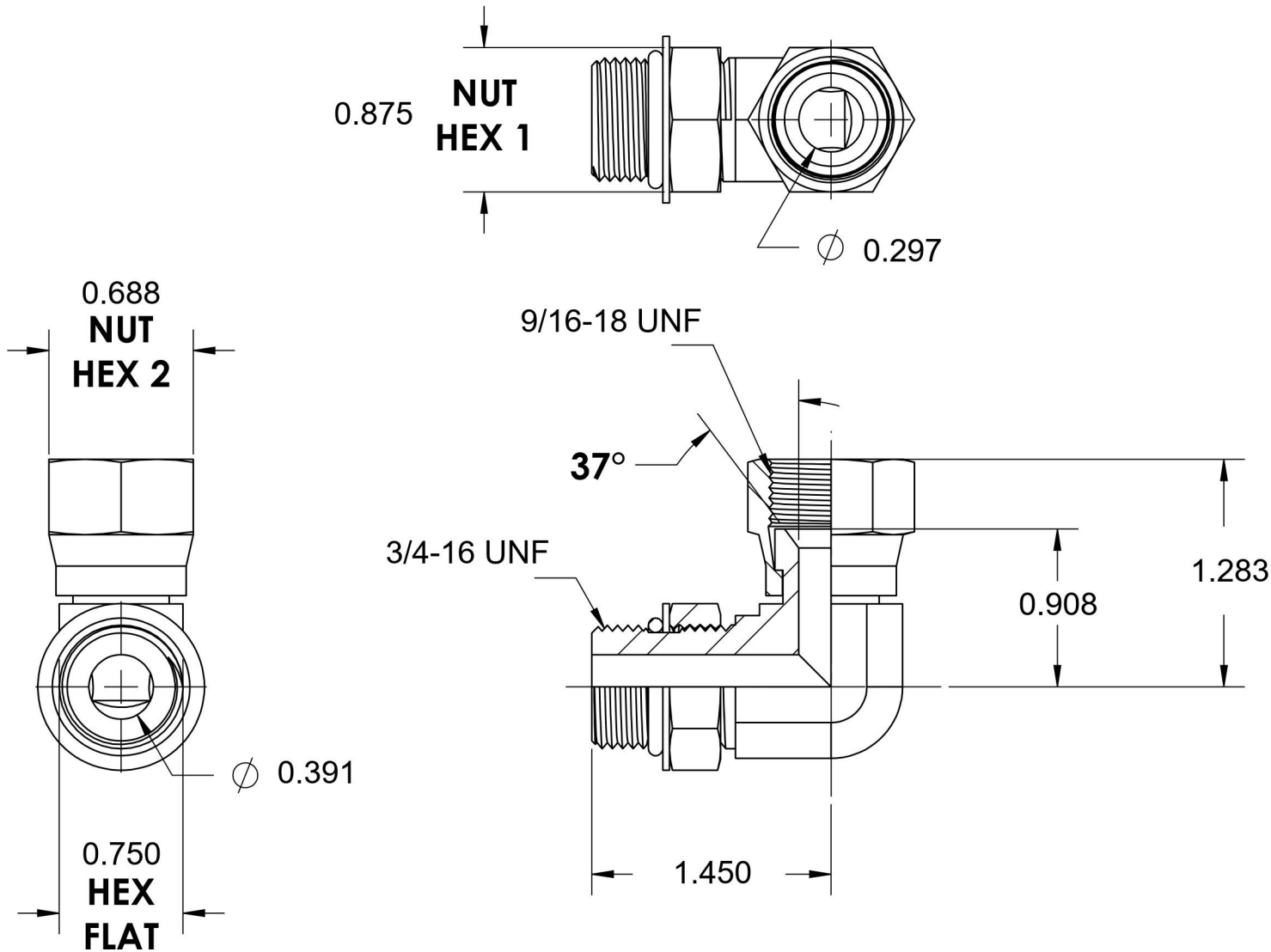

6701 Cochran Road
Solon, Ohio 44139
Phone: (440) 248-1880
Toll Free: 1-888-331-1523

Temperature Rating

-40°F to 250°F

Pressure Rating

6000 psi

Material

C1045 Steel

Finish

Trivalent Zinc

Industry Standards

SAE J1926, SAE J514
ASTM B633

Series

6809-NWO-FG

Series Description

SAE J514 37° Flare Swivel 90°
Adjustable Port Elbow