

7004-04-02

Steel, SAE J514 37° Flare BSPP Swivel Line Adapter, 1/4" Male JIC x 1/8-28 Female BSPP Swivel

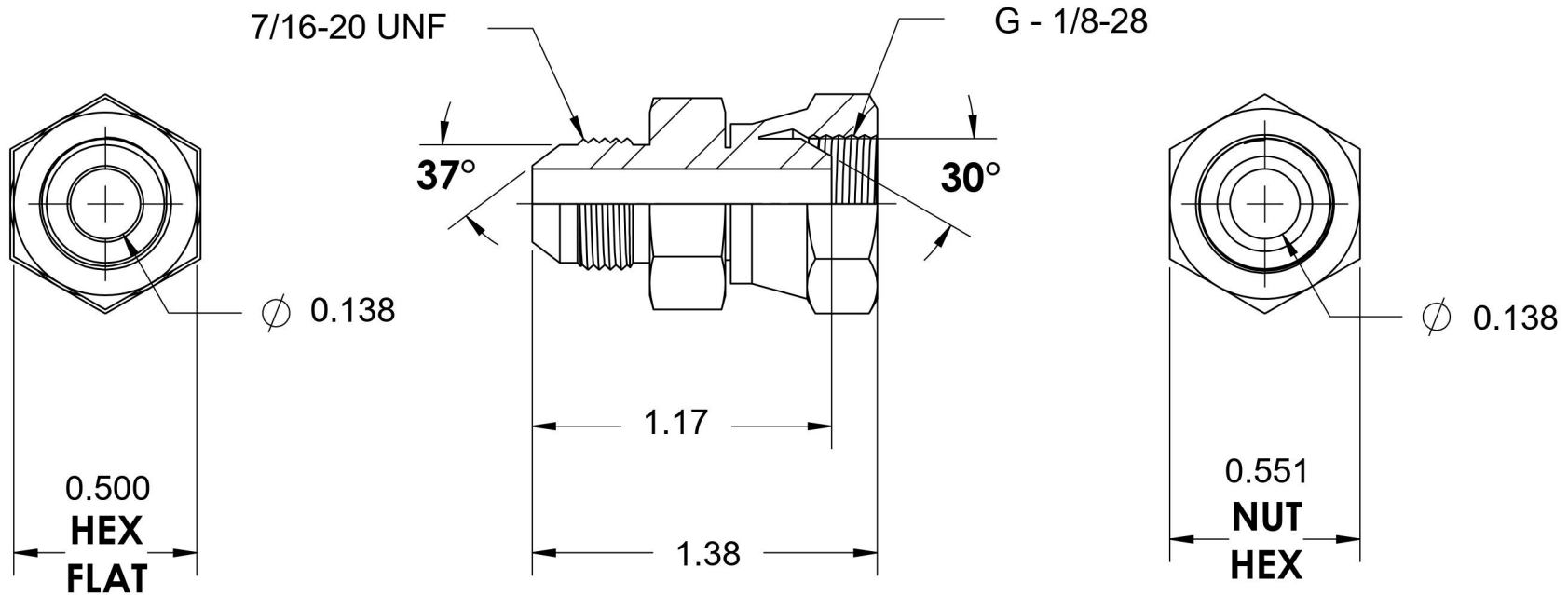
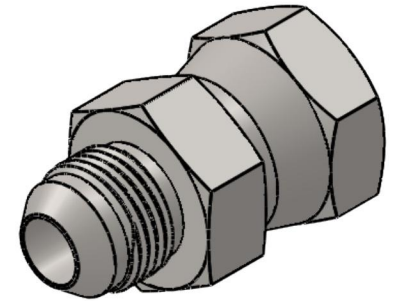

6701 Cochran Road
Solon, Ohio 44139
Phone: (440) 248-1880
Toll Free: 1-888-331-1523

Temperature Rating

-65°F to 500°F

Pressure Rating

5000 psi

Material

C1045 / 12L14 Steel

Finish

Trivalent Zinc

Industry Standards

SAE J514, ISO 8434-6

ASTM B633

Series

7004

Series Description

SAE J514 37° Flare BSPP
Swivel Line Adapter