

D0319-18

Steel, DIN 2353 Double Bite Cutting Ring, 18mm Tube OD

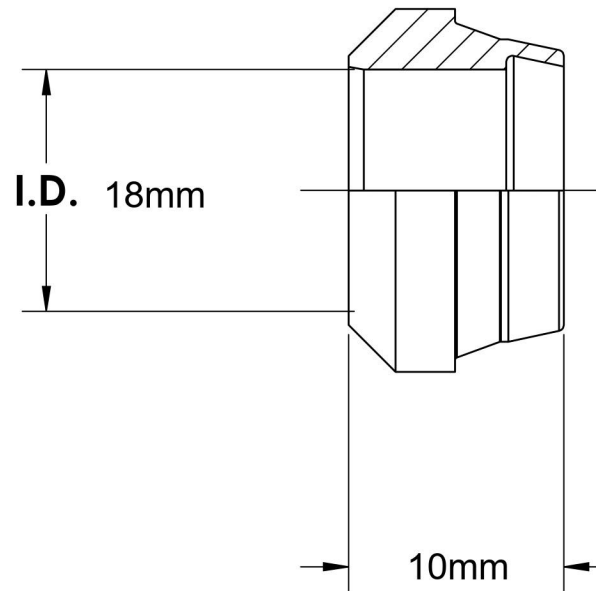
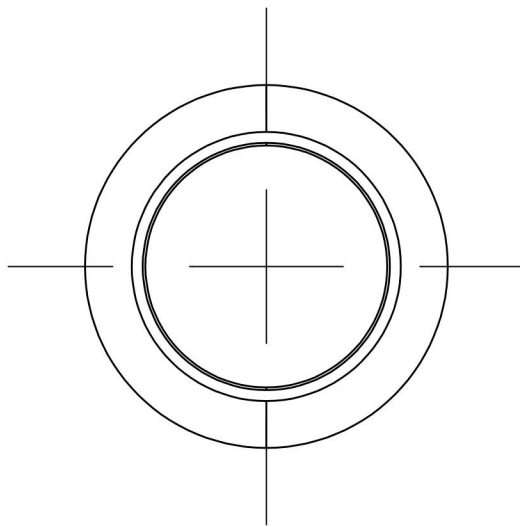
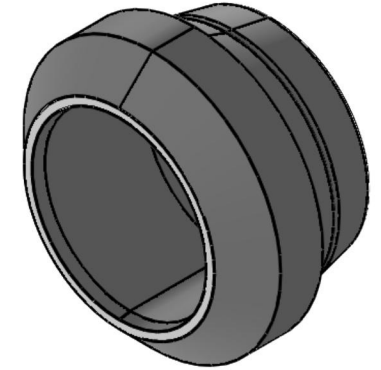

6701 Cochran Road
Solon, Ohio 44139
Phone: (440) 248-1880
Toll Free: 1-888-331-1523

| | | | |
|---|---------------------------------|---|--|
| Temperature Rating -65°F to 500°F | Material Carbon Steel | Industry Standards DIN 2353, ISO 8434-1 | Series D0319 |
| Pressure Rating 5802psi | Finish Zinc Nickel | | Series Description DIN 2353 Flareless Double Bite Tube Sleeve |