

1800-16-24-SS

Stainless Steel, SAE J514 37° Flare Code 62 Flange Adapter, 1" Male JIC x 1-1/2" Split Flange Head

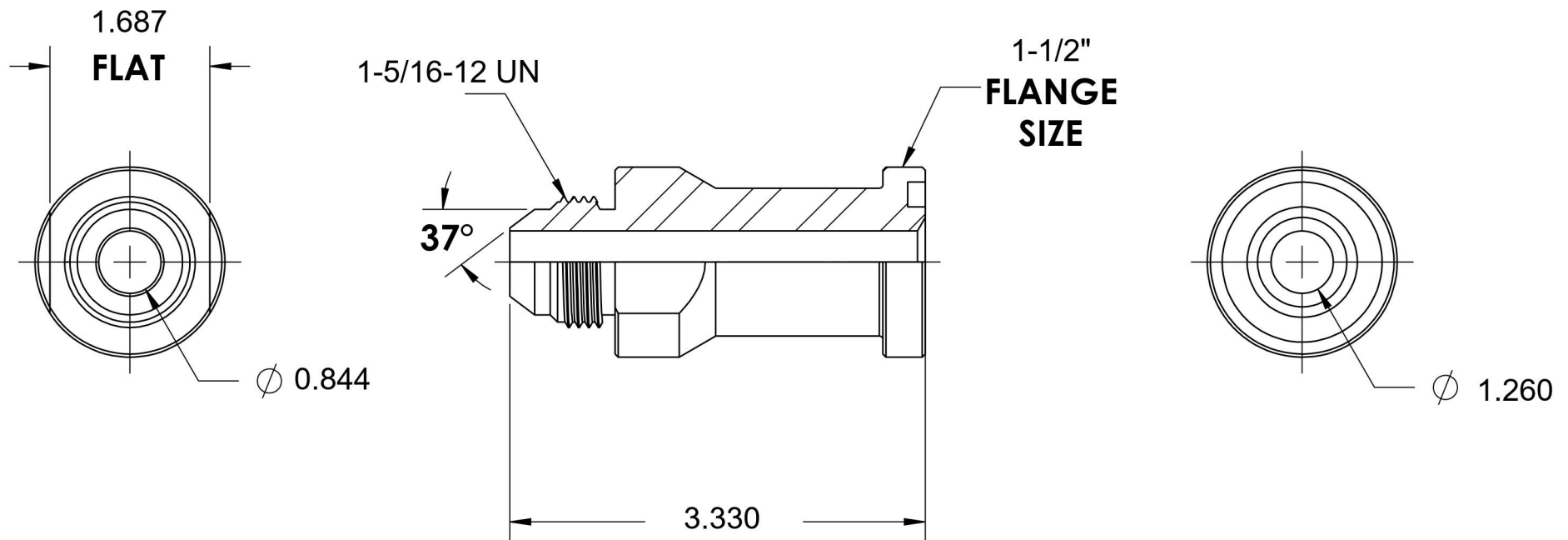

6701 Cochran Road
Solon, Ohio 44139
Phone: (440) 248-1880
Toll Free: 1-888-331-1523

Temperature Rating -425°F to 1200°F	Material 316/316L Stainless Steel	Industry Standards SAE J518 Code 62, SAE J514	Series 1800-SS
Pressure Rating 3000 psi	Finish Passivation		Series Description SAE J514 37° Flare Code 62 Flange Adapter