

6506-12-12

Steel, SAE J514 37° Flare Swivel Female Connector, 3/4" Female NPTF x 3/4" Female JIC Swivel

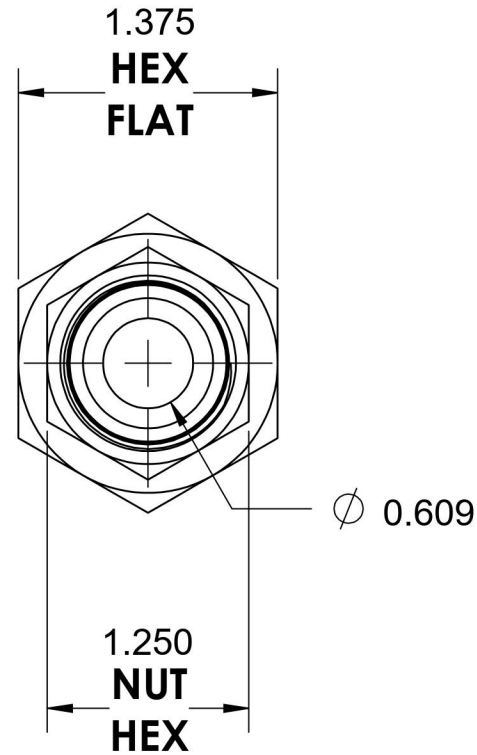
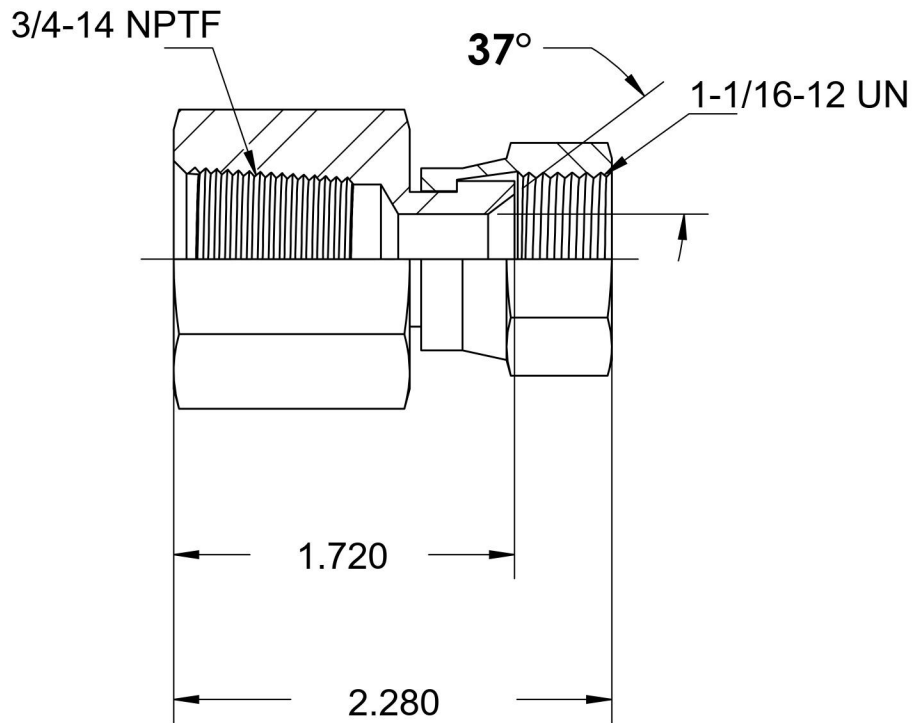
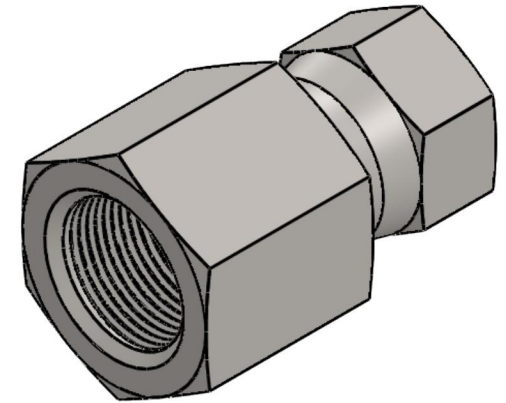

6701 Cochran Road
Solon, Ohio 44139
Phone: (440) 248-1880
Toll Free: 1-888-331-1523

Temperature Rating	Material	Industry Standards SAE J514 , SAE J476 ASTM B633	Series
-65°F to 500°F	C1045/12L14 Steel		6506
Pressure Rating	Finish	Series Description	
4000 psi	Trivalent Zinc	SAE J514 37° Flare Swivel Female Connector	