

# 1803-20-16

Steel, SAE J514 37° Flare Code 62 Flange 45° Swept Elbow, 2" Male JIC x 1" Split Flange Head

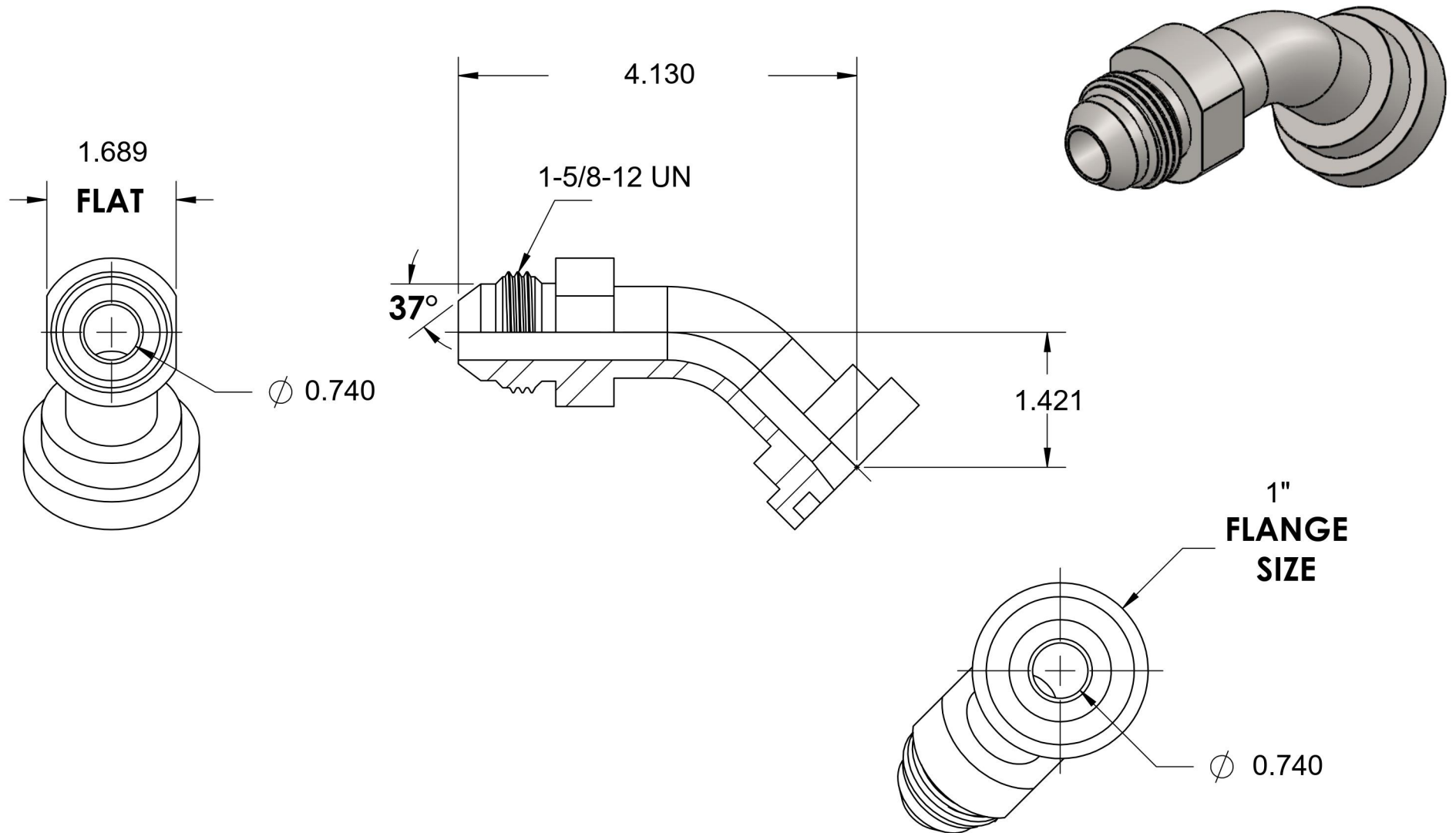

6701 Cochran Road  
Solon, Ohio 44139  
Phone: (440) 248-1880  
Toll Free: 1-888-331-1523

<b>Temperature Rating</b>	<b>Material</b>	<b>Industry Standards</b>	<b>Series</b>
-65°F to 500°F	S20C Steel	SAE J518 Code 62, SAE J514 ASTM B633	1803
<b>Pressure Rating</b>	<b>Finish</b>		<b>Series Description</b>
4000psi	Trivalent Zinc		SAE J514 37° Flare Code 62 Flange 45° Swept Elbow