

C6400-06-06-O

Steel, SAE J514 Flareless Tube Port Connector, 3/8" Flareless Bite Type x 9/16-18 Male ORB

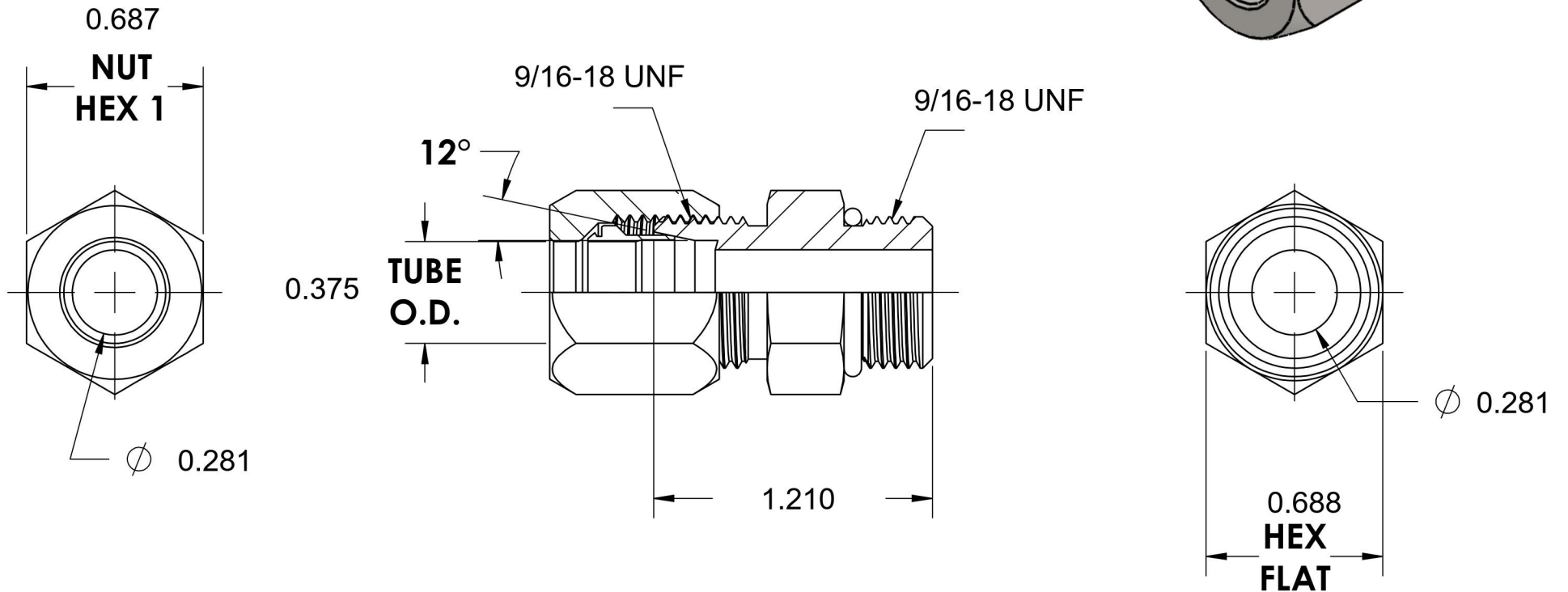
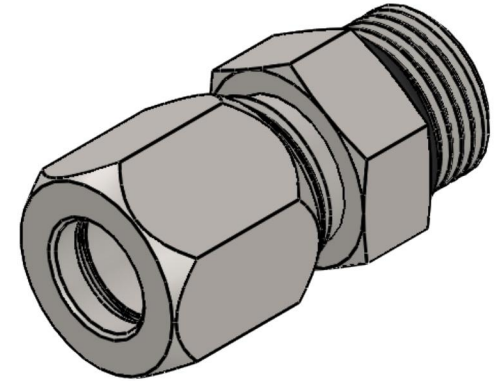

6701 Cochran Road
Solon, Ohio 44139
Phone: (440) 248-1880
Toll Free: 1-888-331-1523

Temperature Rating

-40°F to 250°F

Pressure Rating

6000psi

Material

C1045 Steel

Finish

Trivalent Zinc

Industry Standards

SAE J514, SAE J1926
ASTM B633

Series

C6400-O

Series Description

SAE J514 Flareless Tube Port Connector