

# 7202-04-06-NWO-FG

Steel, SAE J514 37° Flare Male BSPP Adjustable (Type H) Port 90° Elbow, 1/4" Male JIC x 3/8-19 Male BSPP Adjustable ORR

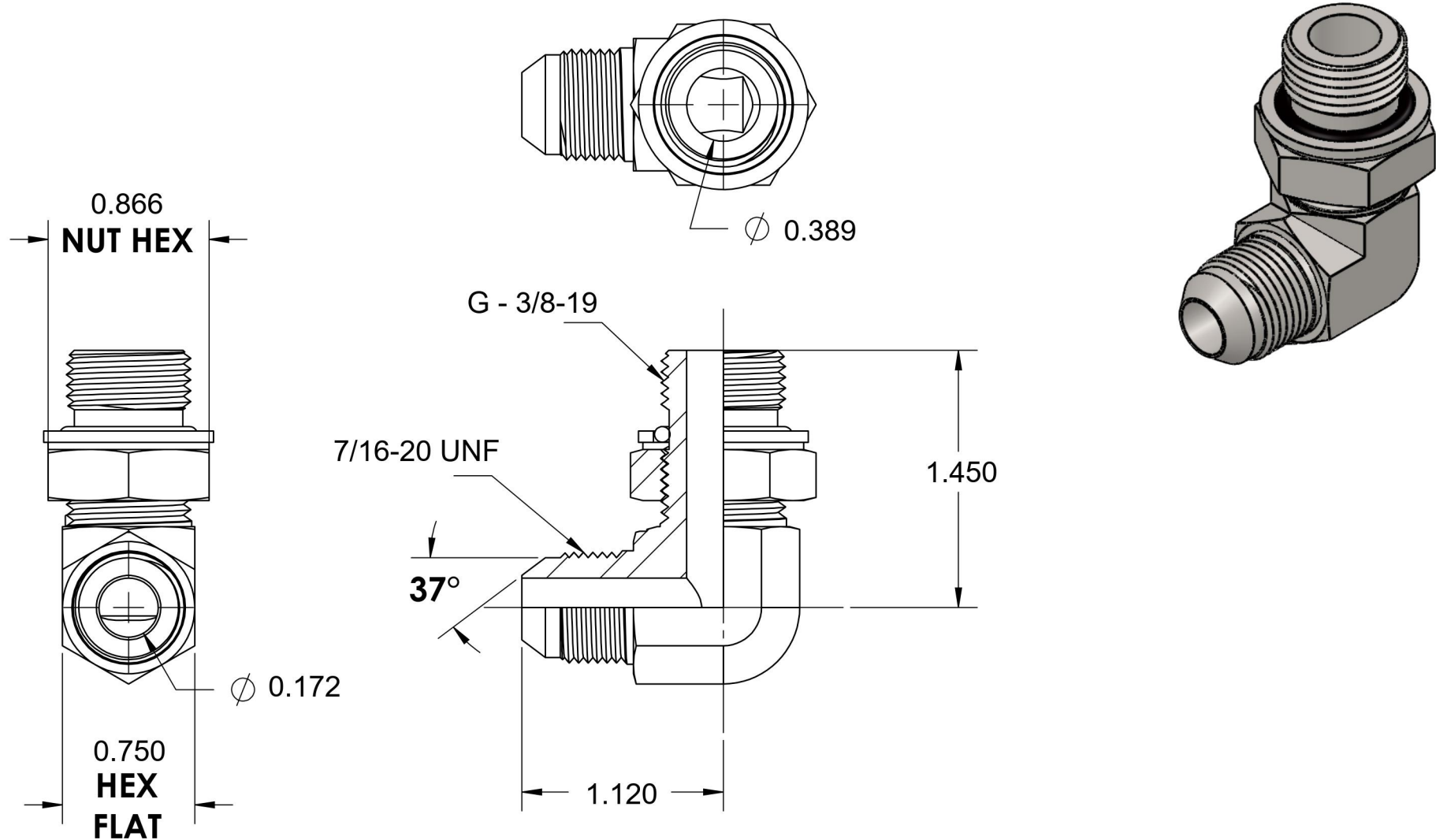

6701 Cochran Road  
Solon, Ohio 44139  
Phone: (440) 248-1880  
Toll Free: 1-888-331-1523

<b>Temperature Rating</b>	<b>Material</b>	<b>Industry Standards</b>	<b>Series</b>
-40°F to 250°F	C1045 Steel	SAE J514, ISO 1179 ASTM B633	7202-NWO-FG-ORR
<b>Pressure Rating</b>	<b>Finish</b>		<b>Series Description</b>
3600 psi	Trivalent Zinc		SAE J514 37° Flare Male BSPP Adjustable (Type H) Port 90° Elbow