

6504-12-08-SS

Stainless Steel, SAE J514 37° Flare Swivel Adapter, 3/4" Male JIC x 1/2" Female JIC Swivel

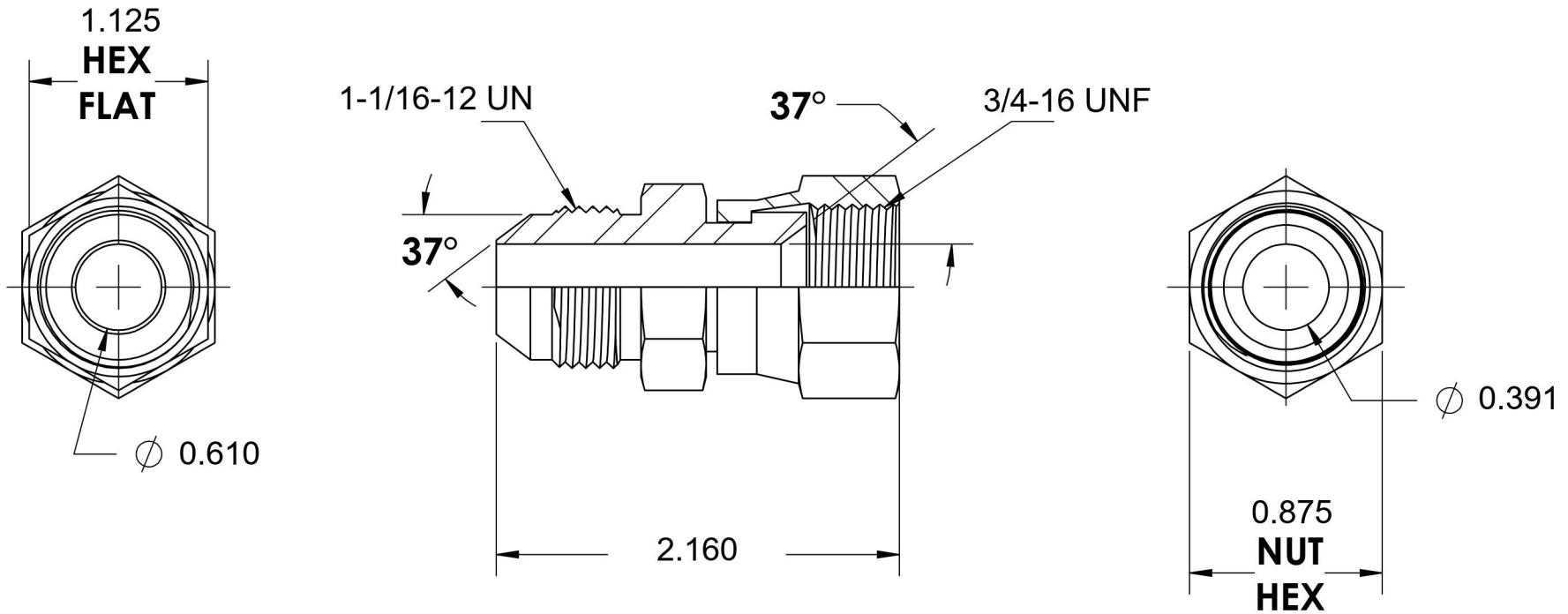
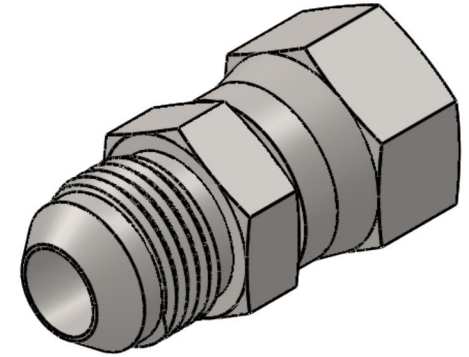

6701 Cochran Road
Solon, Ohio 44139
Phone: (440) 248-1880
Toll Free: 1-888-331-1523

Temperature Rating

-425°F to 1200°F

Pressure Rating

5000 psi

Material

316/316L Stainless Steel

Finish

Passivated

Industry Standards

SAE J514

Series

6504-SS

Series Description

SAE J514 37° Flare Swivel Adapter