

C2402-06-06-SS

Stainless Steel, SAE J514 Flareless Tube Male Flared Adapter, 3/8" Flareless Bite Type x 3/8" Male JIC

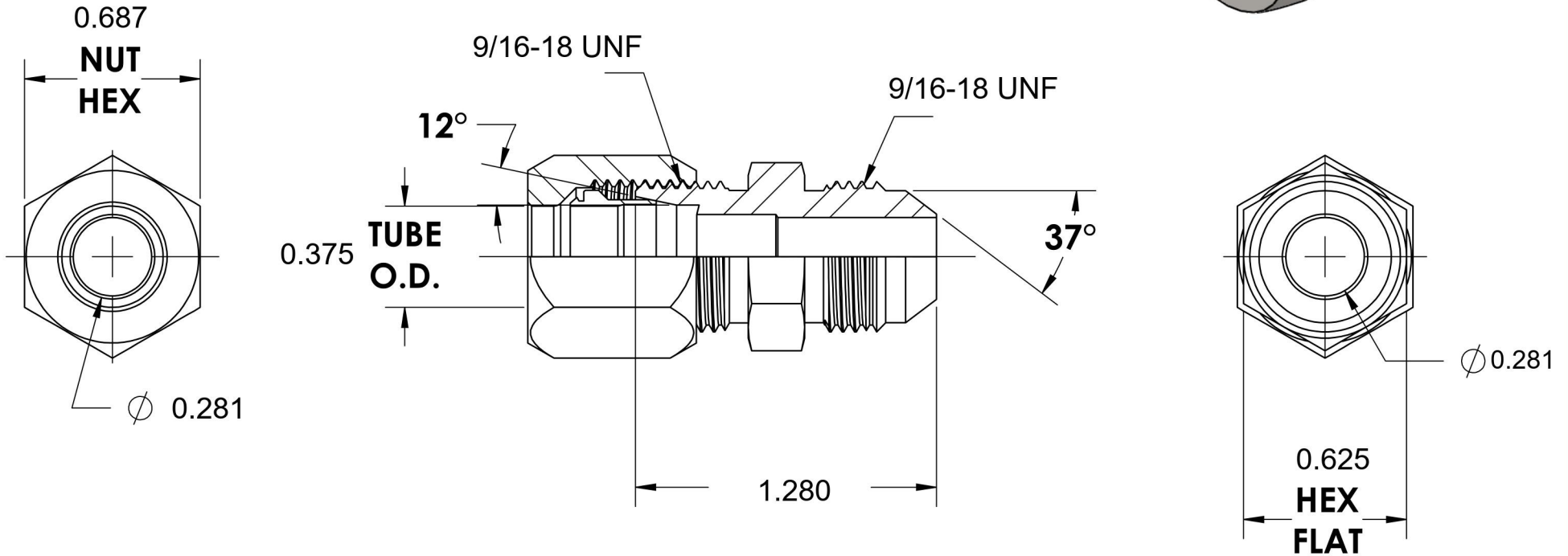
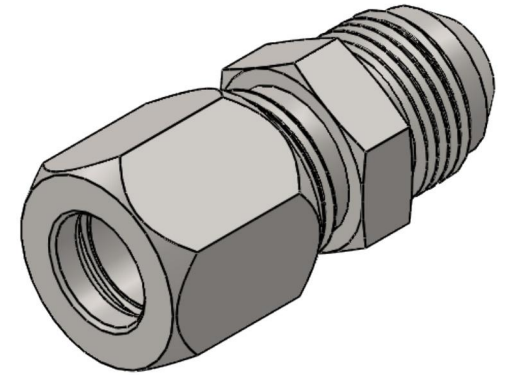

6701 Cochran Road
Solon, Ohio 44139
Phone: (440) 248-1880
Toll Free: 1-888-331-1523

Temperature Rating	Material	Industry Standards	Series
-425°F to 1200°F	316/316L Stainless	SAE J514	C2402
Pressure Rating	Finish		Series Description
7700psi	Passivation		SAE J514 Flareless Tube Male Flared Adapter