

1501-12-08-FG

Steel, SAE J514 NPSM Swivel 90° Male Elbow, 3/4" Male NPTF 30° x 1/2" Female NPSM Swivel

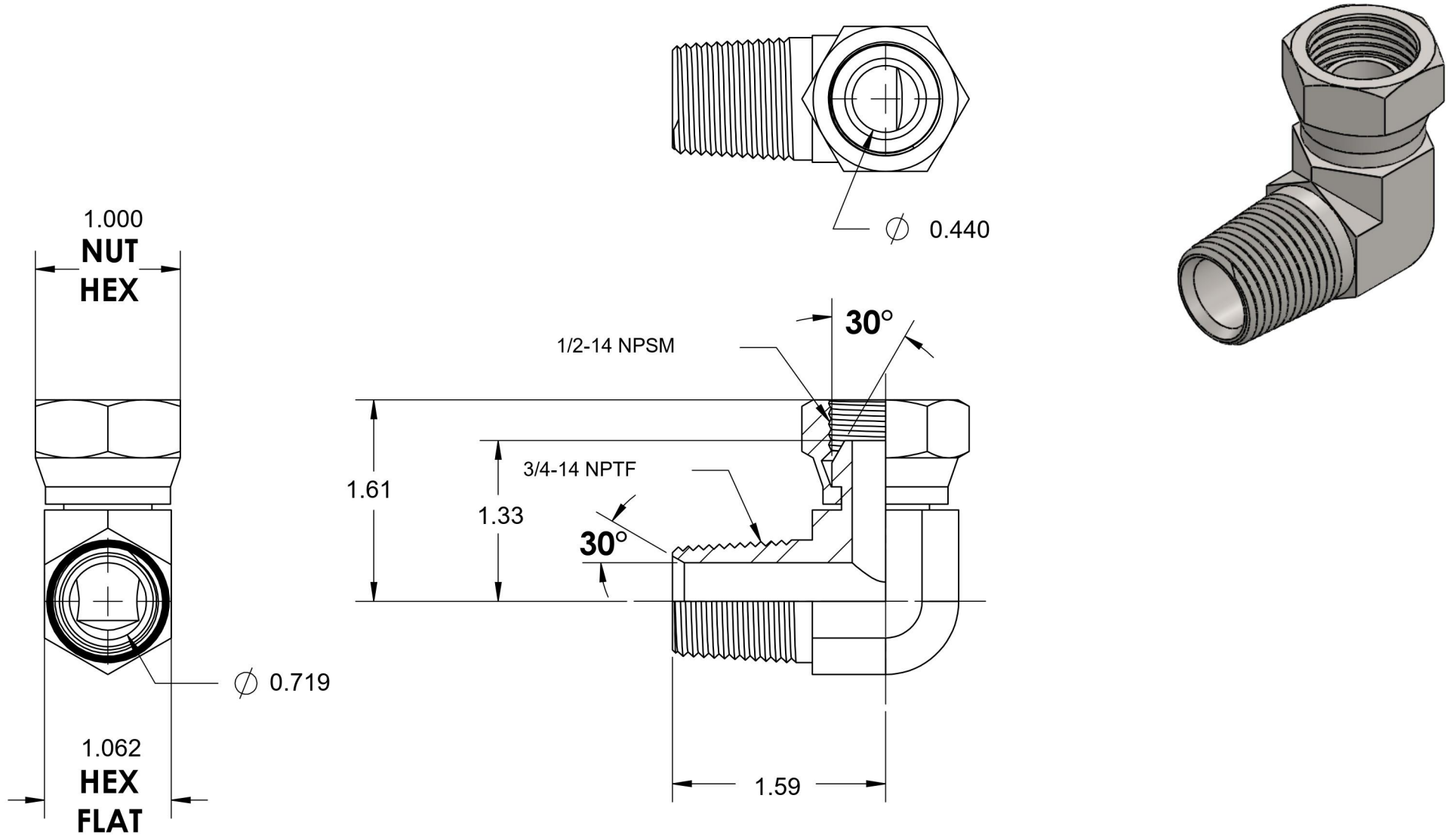

6701 Cochran Road
Solon, Ohio 44139
Phone: (440) 248-1880
Toll Free: 1-888-331-1523

Temperature Rating -65°F to 500°F	Material C1045 Steel	Industry Standards SAE J514, SAE J476 ASTM B633	Series 1501-FG
Pressure Rating 4000 psi	Finish Trivalent Zinc		Series Description SAE J514 NPSM Swivel 90° Male Elbow