

# FS2603-10-10-10-FG

Steel, SAE J1453 O-Ring Face Seal Union Tee, 5/8" Male ORFS

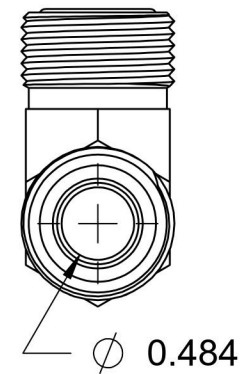
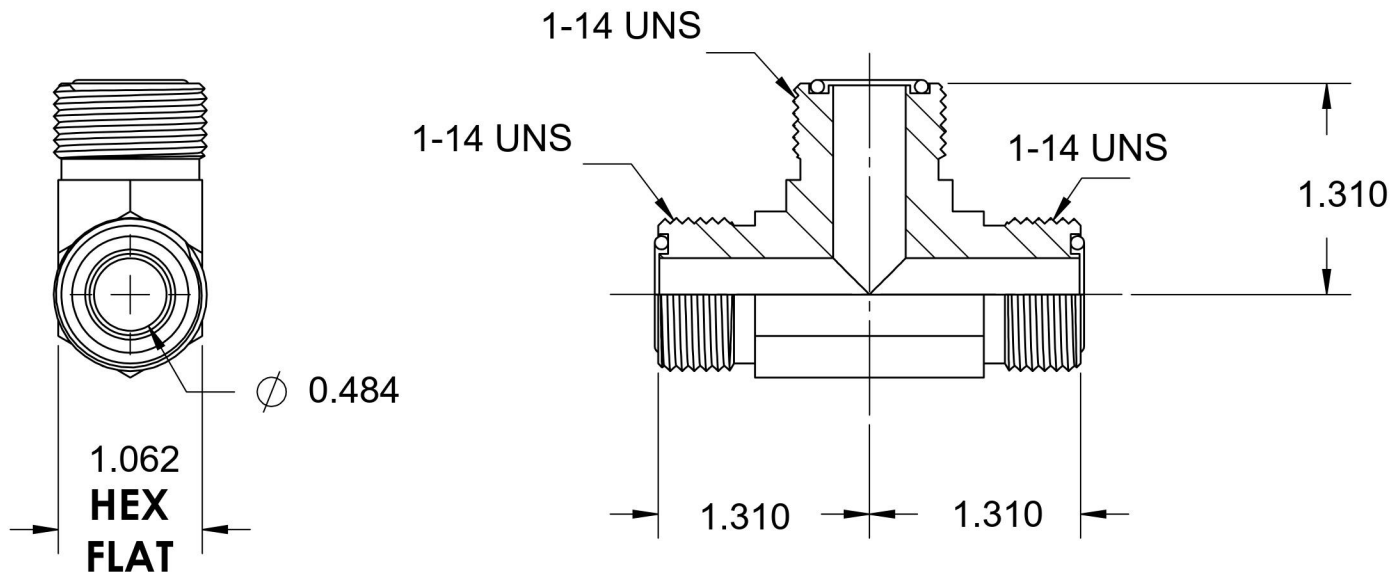
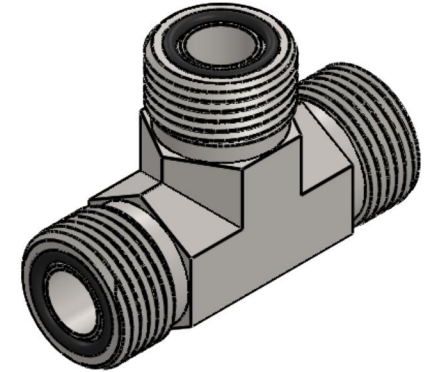
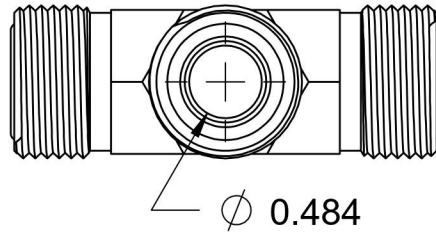

6701 Cochran Road  
Solon, Ohio 44139  
Phone: (440) 248-1880  
Toll Free: 1-888-331-1523

**Temperature Rating**

-40°F to 250°F

**Pressure Rating**

6000 psi

**Material**

C1045 Steel

**Finish**

Trivalent Zinc

**Industry Standards**

SAE J1453, SAE J515  
ASTM B633

**Series**

FS2603-FG

**Series Description**

SAE J1453 O-Ring  
Face Seal Union Tee