

9022-10-08-SS

Stainless Steel, ISO 1179 BSPP Port/Line Union, 5/8-14 Male BSPP 60° Line/Port x 1/2-14 Male BSPP 60° Line/Port

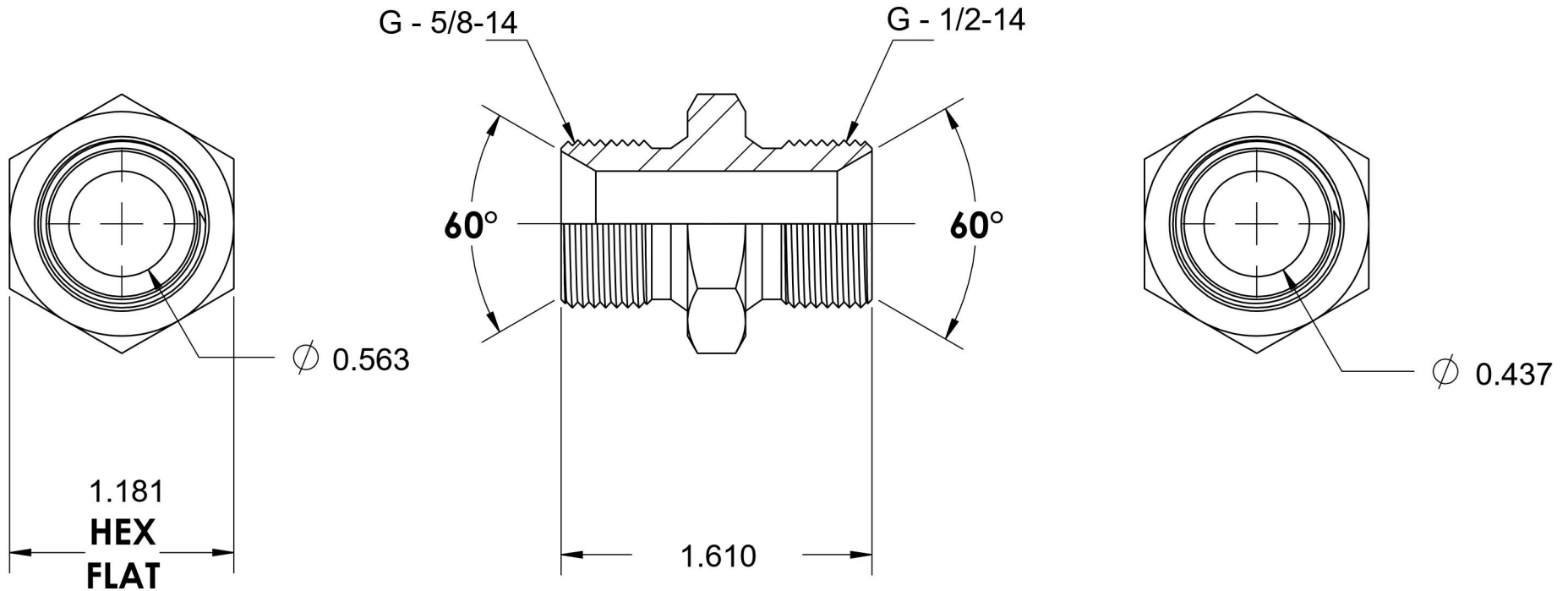

6701 Cochran Road
Solon, Ohio 44139
Phone: (440) 248-1880
Toll Free: 1-888-331-1523

| | | | |
|---------------------------|--------------------------|---------------------------|----------------------------------|
| Temperature Rating | Material | Industry Standards | Series |
| -425°F to 1200°F | 316/316L Stainless Steel | ISO 1179, ISO 8434-6 | 9022-SS |
| Pressure Rating | Finish | | Series Description |
| 2900 psi | Passivated | | ISO 1179 BSPP Port/Line Union |