

FS6400-04-05-O

Steel, SAE J1453 O-Ring Face Seal Port Connector, 1/4" Male ORFS x 1/2-20 Male ORB

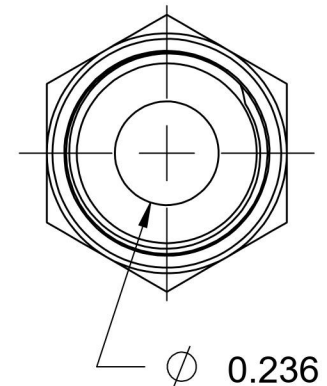
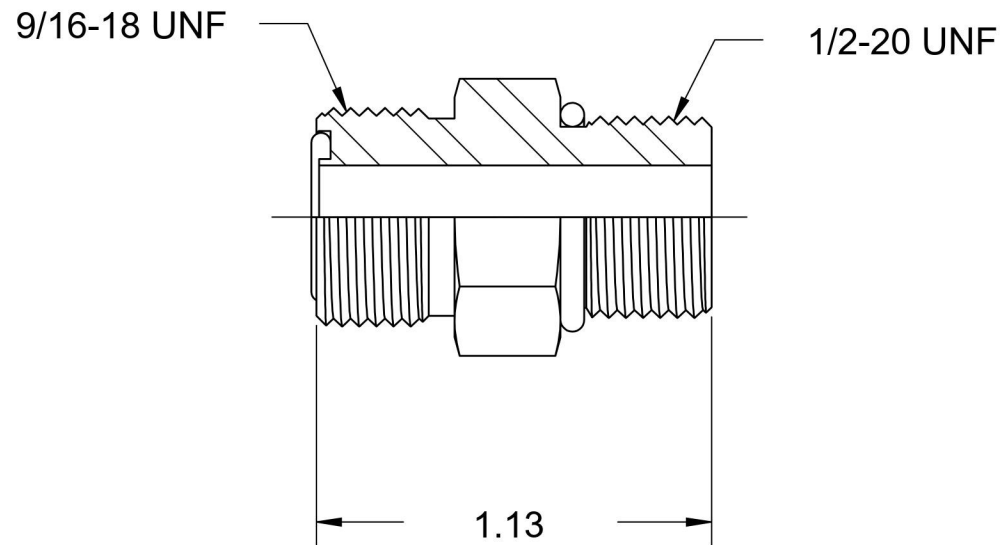
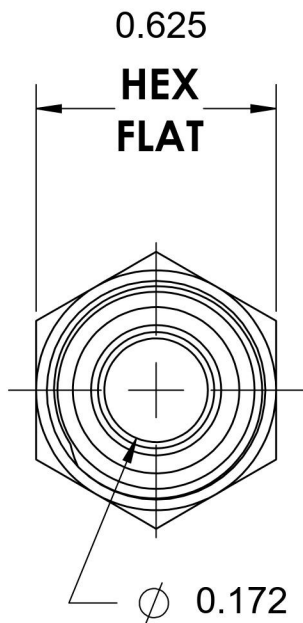
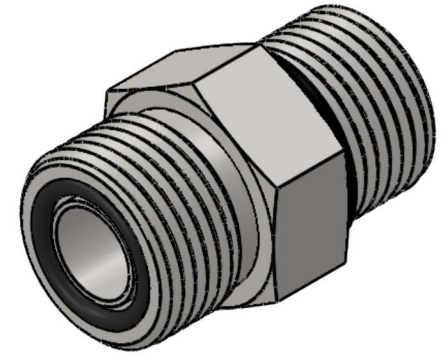

6701 Cochran Road
Solon, Ohio 44139
Phone: (440) 248-1880
Toll Free: 1-888-331-1523

Temperature Rating	Material	Industry Standards	Series
-40°F to 250°F	C1045 / 12L14 Steel	SAE J1453, SAE J1926-2 ASTM B633	FS6400-O
Pressure Rating	Finish		Series Description
9200 psi	Trivalent Zinc		SAE J1453 O-Ring Face Seal Port Connector