

5501-06-06-FG

Steel, SAE J514 Pipe 45° Male Elbow, 3/8" Male NPTF 30° x 3/8" Male NPTF 30°

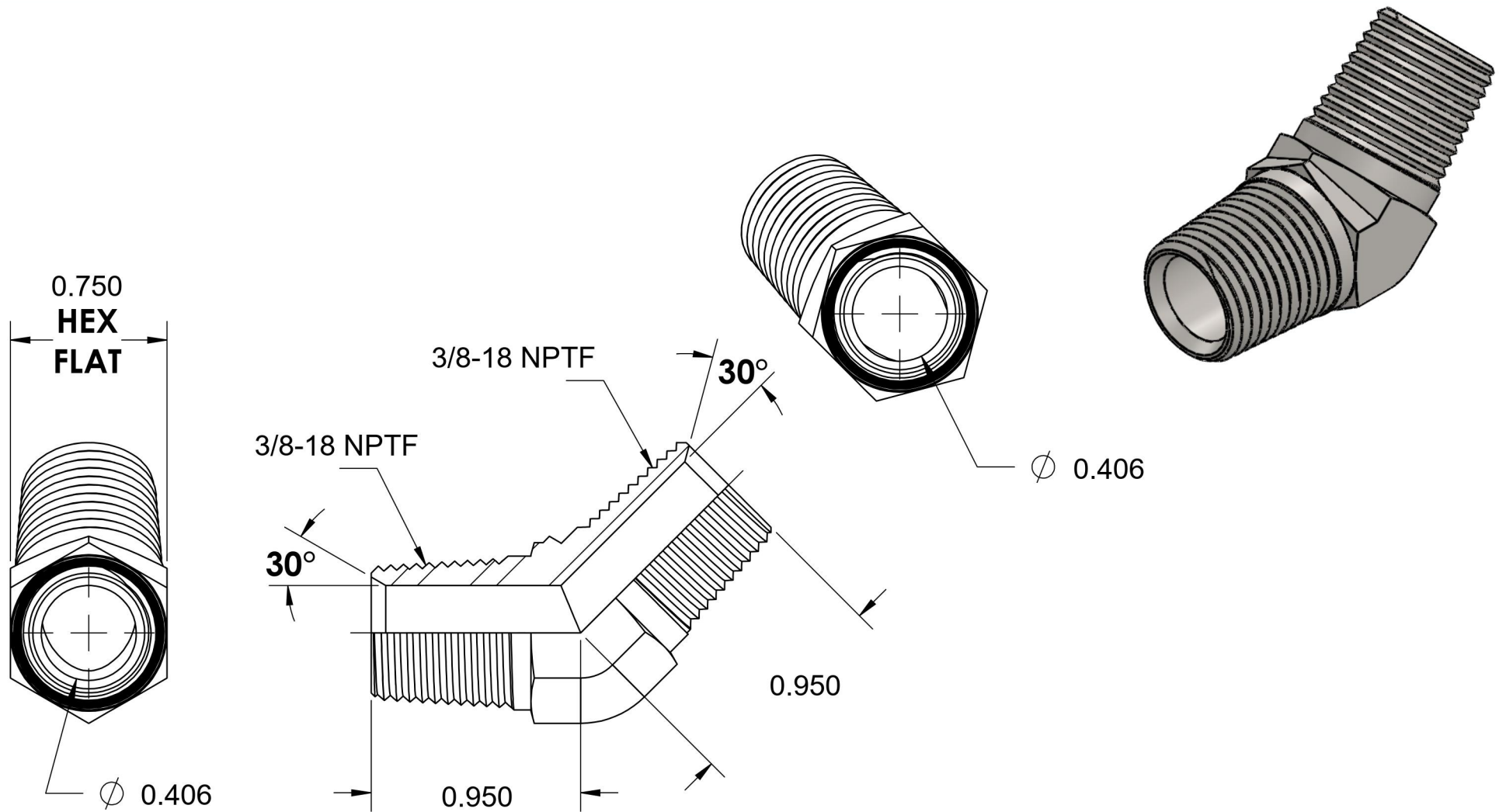

6701 Cochran Road
Solon, Ohio 44139
Phone: (440) 248-1880
Toll Free: 1-888-331-1523

Temperature Rating

-65°F to 500°F

Pressure Rating

6000psi

Material

C1045 Steel

Finish

Trivalent Zinc

Industry Standards

SAE J514 , SAE J476
ASTM B633

Series

5501-FG

Series Description

SAE J514 Pipe 45° Male Elbow