

7007-10-S12-20-SS

Stainless Steel, SAE J514 37° Flare DIN (S) Swivel Adapter, 5/8" Male JIC x M20X1.5 Female DKO Swivel

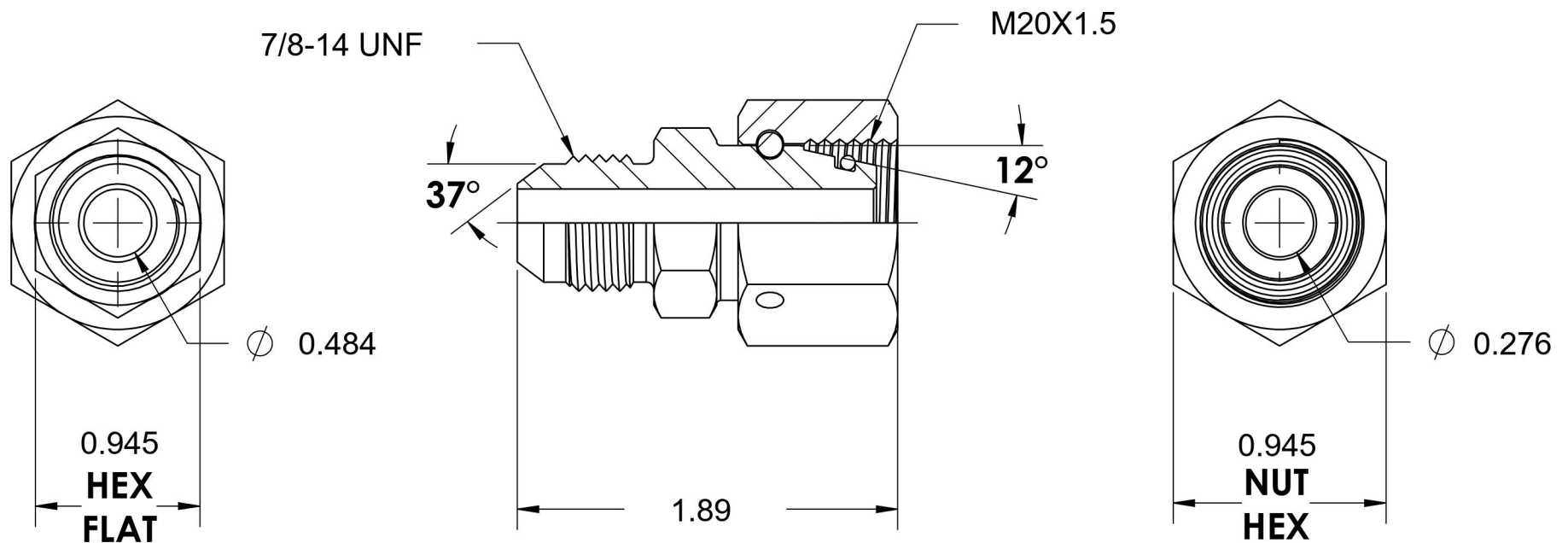

6701 Cochran Road
Solon, Ohio 44139
Phone: (440) 248-1880
Toll Free: 1-888-331-1523

Temperature Rating

-40°F to 250°F

Pressure Rating

5000 psi

Material

316/316L Stainless Steel

Finish

Passivated

Industry Standards

SAE J514, ISO 8434-1

DIN 2353

Series

7007-DIN HEAVY-SS

Series Description

SAE J514 37° Flare
DIN (S) Swivel Adapter