

7012-06-06

Steel, SAE J514 37° Flare Male BSPP Type (G) Port Connector, 3/8" Male JIC x 3/8-19 Male BSPP ORR

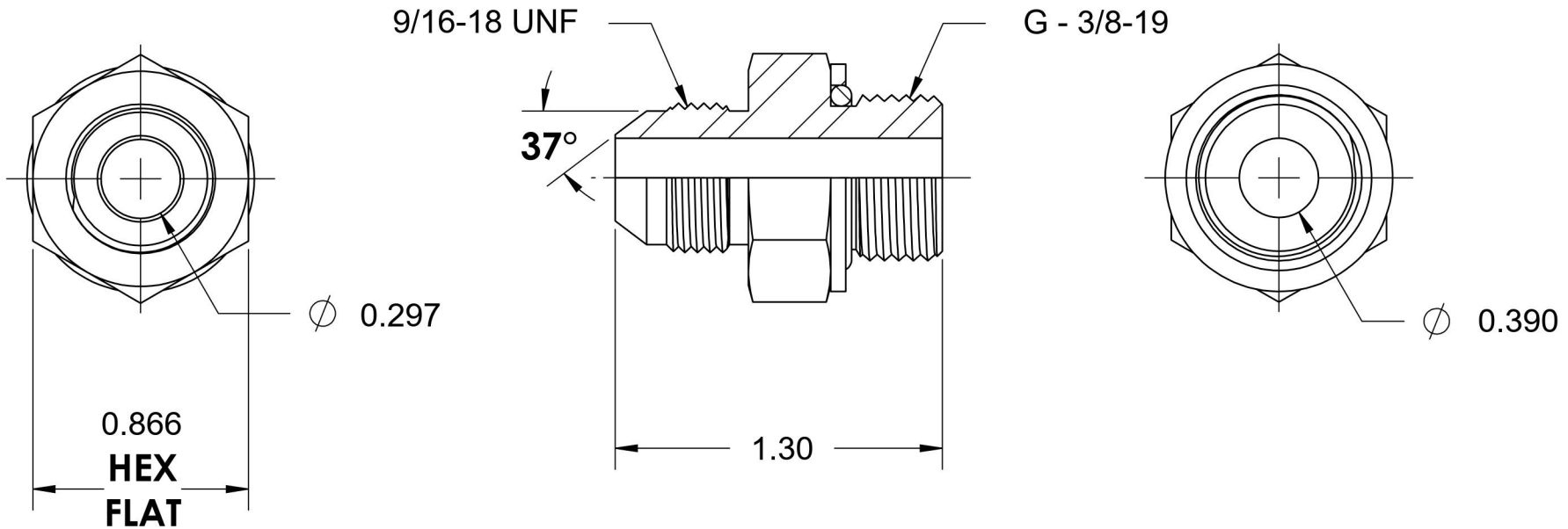

6701 Cochran Road
Solon, Ohio 44139
Phone: (440) 248-1880
Toll Free: 1-888-331-1523

Temperature Rating	Material	Industry Standards	Series
-40°F to 250°F	C1045 / 12L14 Steel	SAE J514, ISO 1179	7012-ORR
Pressure Rating	Finish	ASTM B633	
5000 psi	Trivalent Zinc		Series Description SAE J514 37° Flare Male BSPP Type (G) Port Connector