

FS7640-10-22-O

Steel, SAE J1453 O-Ring Face Seal Male Metric (ISO 6149) Port Connector, 5/8" Male ORFS x M22X1.5 Male Metric ORB

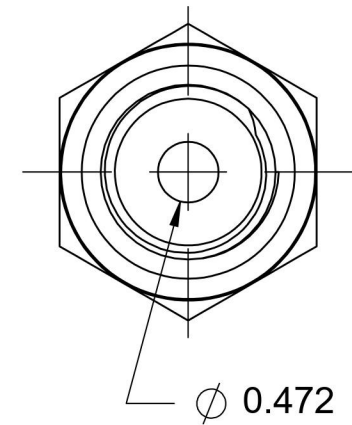
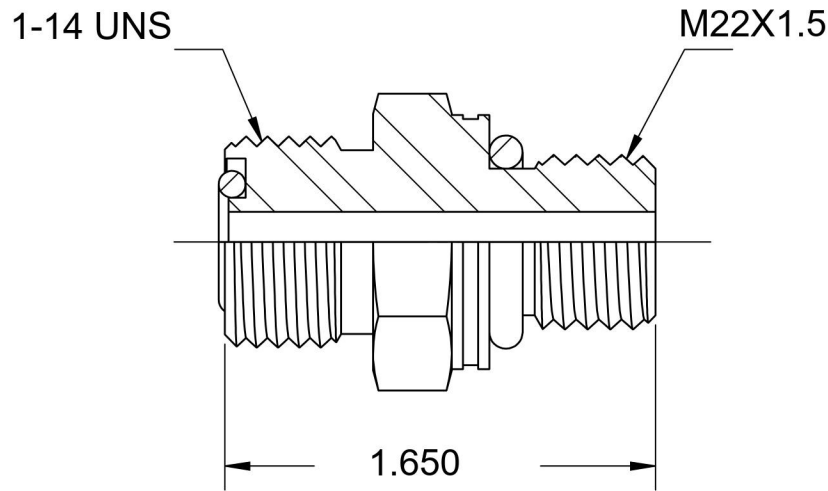
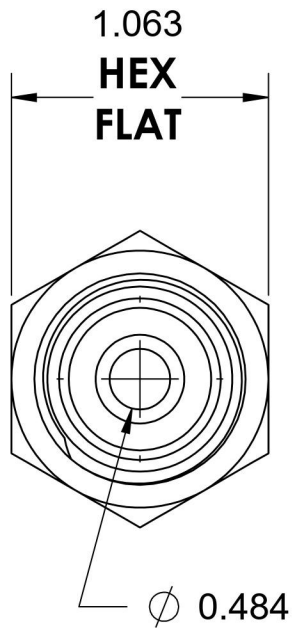
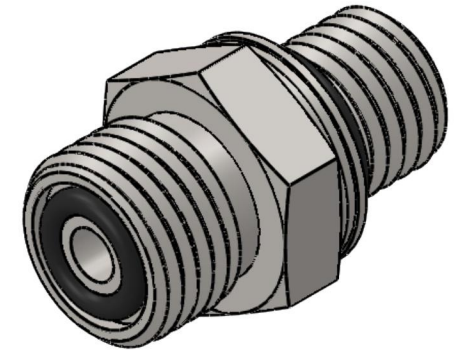

6701 Cochran Road
Solon, Ohio 44139
Phone: (440) 248-1880
Toll Free: 1-888-331-1523

Temperature Rating	Material	Industry Standards	Series
-40°F to 250°F	C1045/12L14 Steel	SAE J1453, ISO 6149-2 SAE J515, ASTM B633	FS7640-O-ISO 6149
Pressure Rating	Finish		Series Description
6000 psi	Trivalent Zinc		SAE J1453 O-Ring Face Seal Male Metric (ISO 6149) Port Connector