

FS2500-08-08-FG

Steel, SAE J1453 O-Ring Face Seal 90° Union Elbow, 1/2" Male ORFS x 1/2" Male ORFS

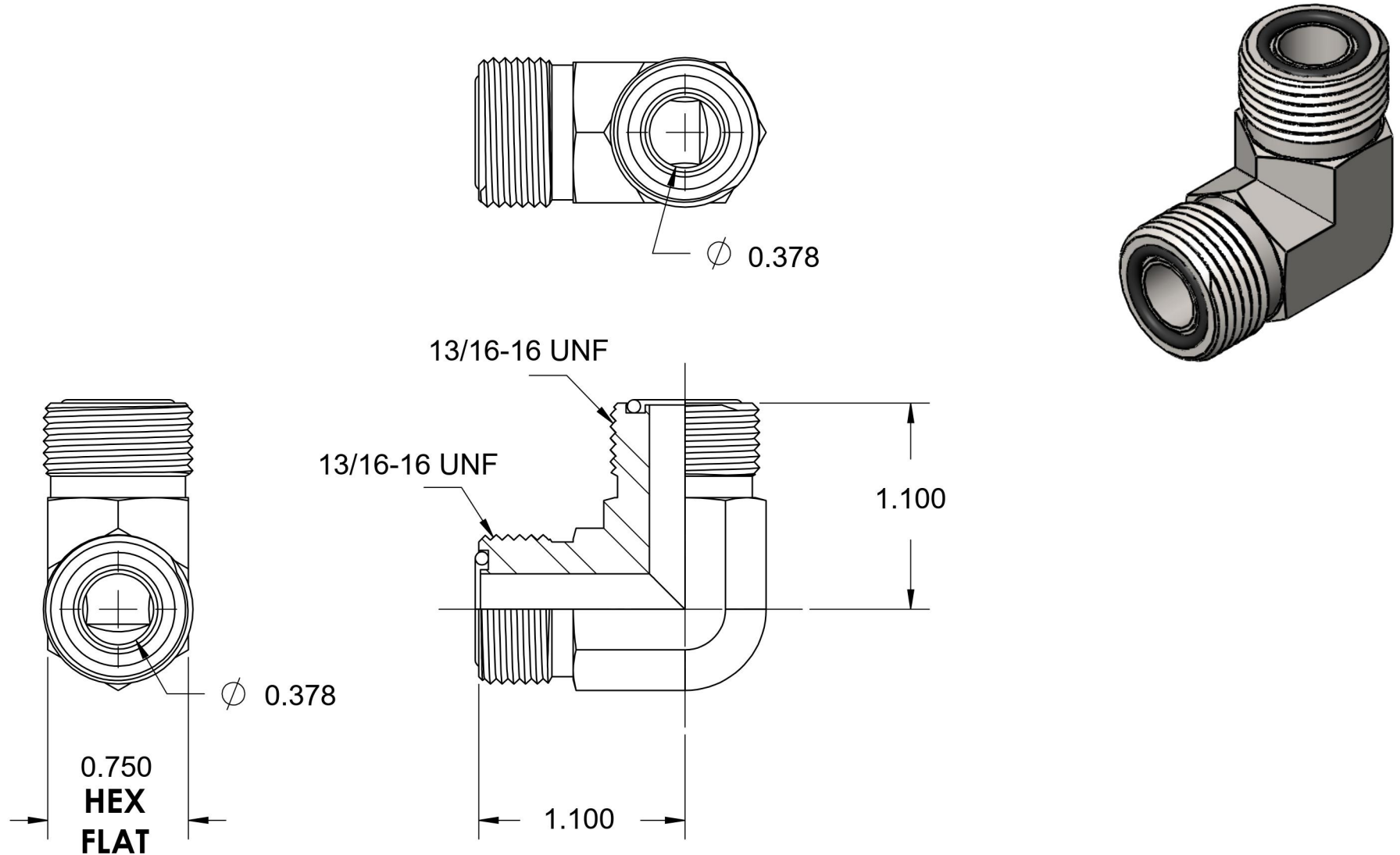

6701 Cochran Road
Solon, Ohio 44139
Phone: (440) 248-1880
Toll Free: 1-888-331-1523

Temperature Rating	Material	Industry Standards	Series
-40°F to 250°F	C1045 Steel	SAE J1453, ASTM B633	FS2500-FG
Pressure Rating	Finish		Series Description
9200psi	Trivalent Zinc		SAE J1453 O-Ring Face Seal 90° Union Elbow