

FS2501-04-04-SS

Stainless Steel, SAE J1453 O-Ring Face Seal 90° Male Elbow, 1/4" Male ORFS x 1/4" Male NPTF 30°

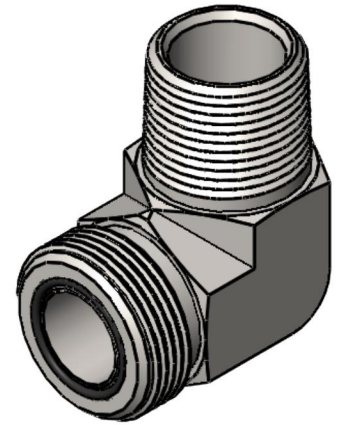
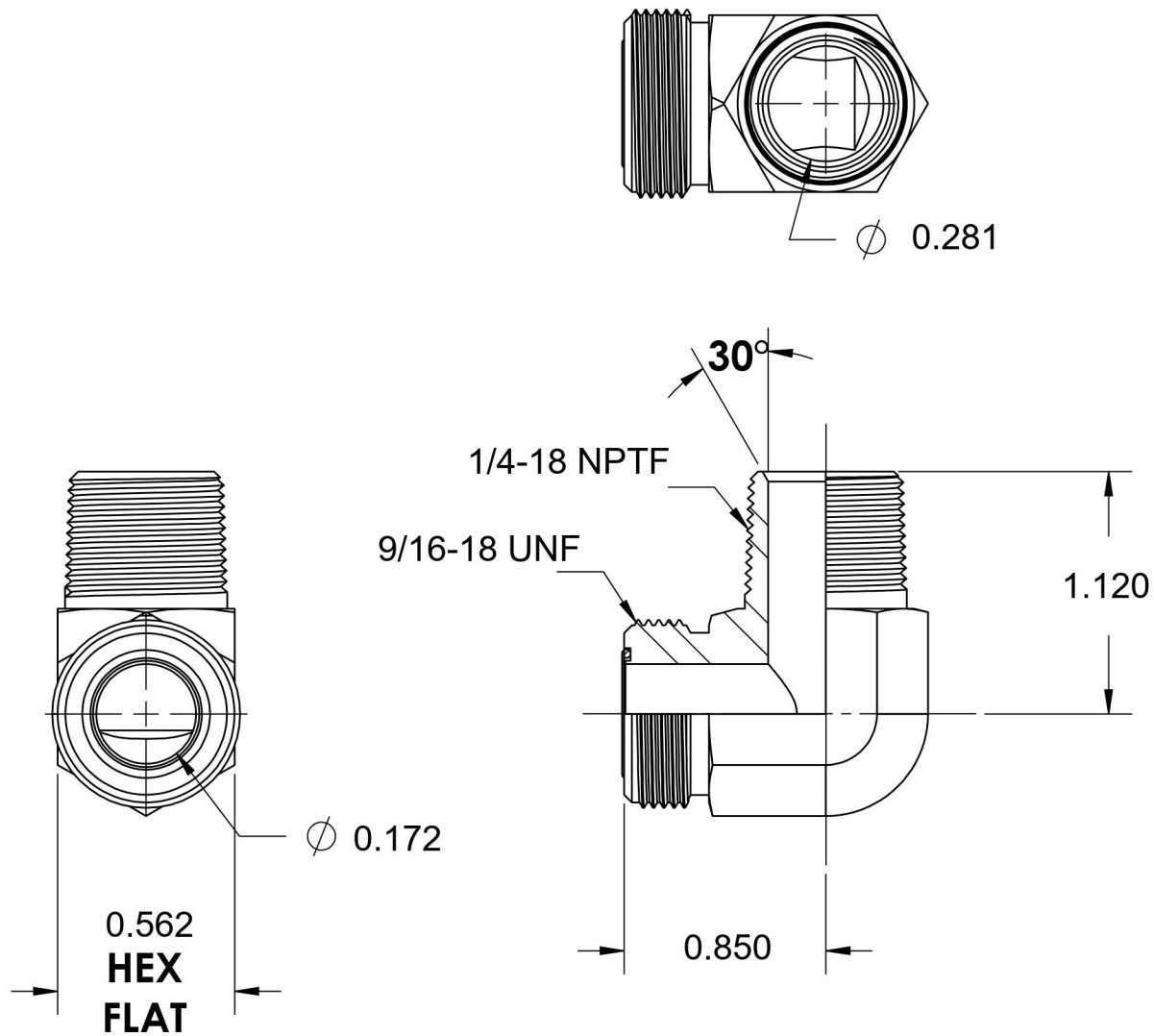

6701 Cochran Road
Solon, Ohio 44139
Phone: (440) 248-1880
Toll Free: 1-888-331-1523

Temperature Rating	Material	Industry Standards	Series
-40°F to 250°F	316/316L Stainless Steel	SAE J1453, SAE J476 SAE J515	FS2501-SS
Pressure Rating	Finish		Series Description
6000 psi	Passivated		SAE J1453 O-Ring Face Seal 90° Male Elbow