

6400-L-10-10-O

Steel, SAE J514 37° Flare Long Port Connector, 5/8" Male JIC x 7/8-14 Male ORB

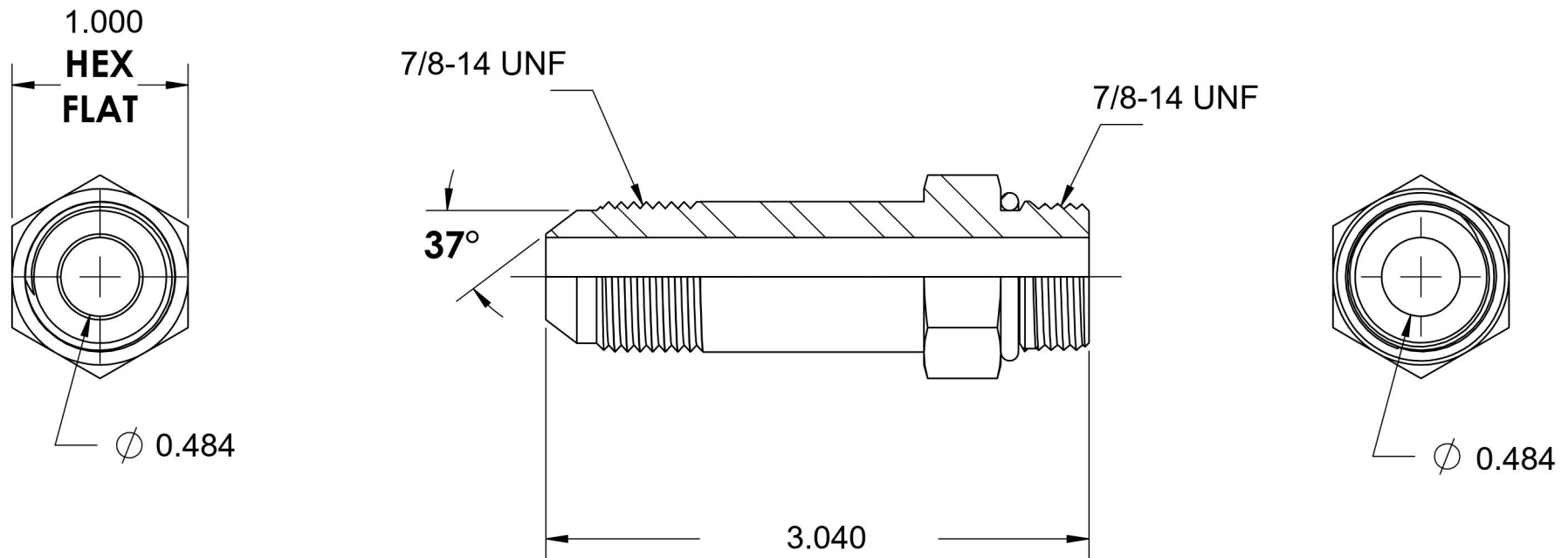
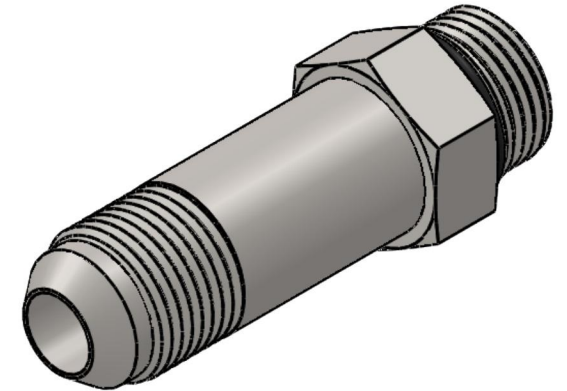

6701 Cochran Road
Solon, Ohio 44139
Phone: (440) 248-1880
Toll Free: 1-888-331-1523

Temperature Rating	Material	Industry Standards	Series
-40°F to 250°F	C1045/12L14 Steel	SAE J514, SAE J1926-3 SAE J515, ASTM B633	6400-L-O
Pressure Rating	Finish		Series Description
5000 psi	Trivalent Zinc		SAE J514 37° Flare Long Port Connector