

# 2603-12-12-12-FG

Steel, SAE J514 37° Flare Union Tee, 3/4" Male JIC

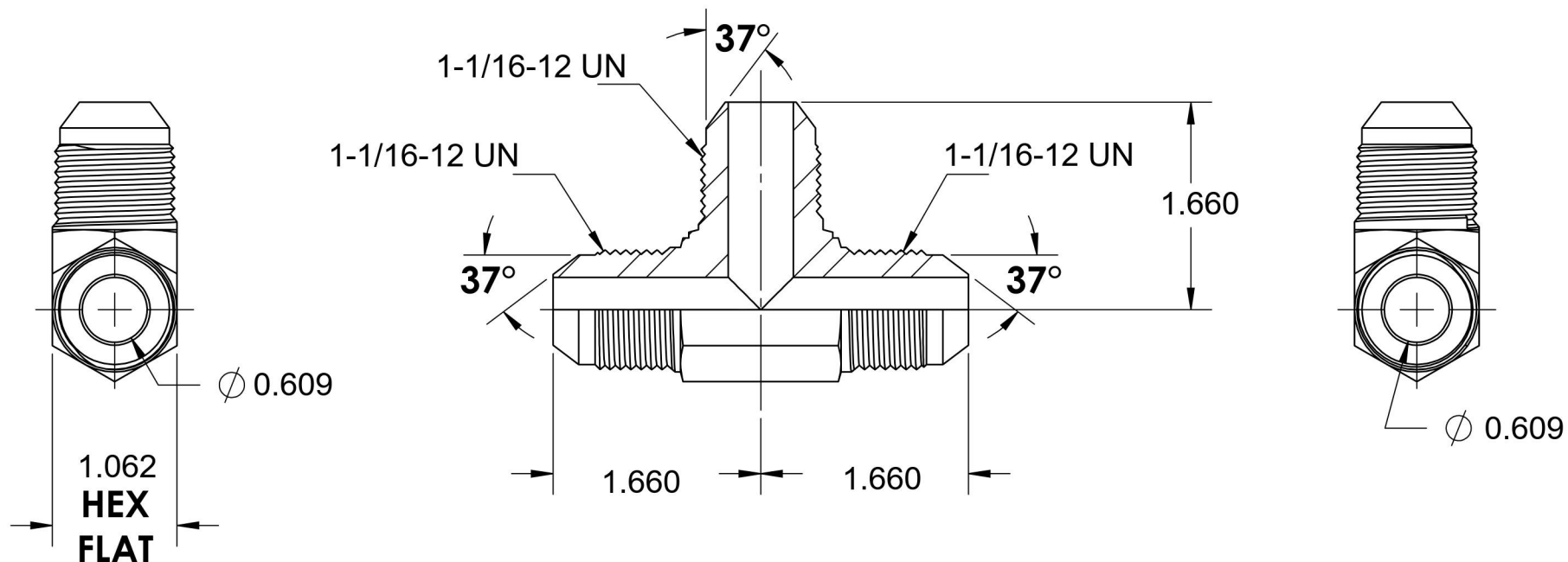
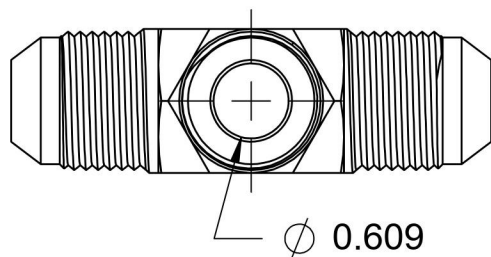

6701 Cochran Road  
Solon, Ohio 44139  
Phone: (440) 248-1880  
Toll Free: 1-888-331-1523

<b>Temperature Rating</b>	<b>Material</b>	<b>Industry Standards</b>	<b>Series</b>
-65°F to 500°F	C1045 Steel	SAE J514, ASTM B633	2603-FG
<b>Pressure Rating</b>	<b>Finish</b>		<b>Series Description</b>
5000 psi	Trivalent Zinc		SAE J514 37° Flare Union Tee