

6400-04-06-O

Steel, SAE J514 37° Flare Port Connector, 1/4" Male JIC x 9/16-18 Male ORB

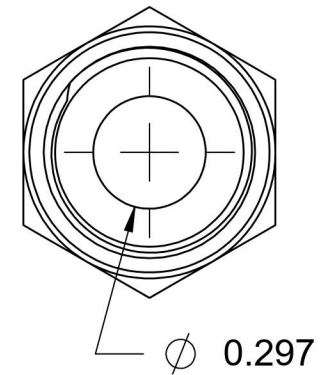
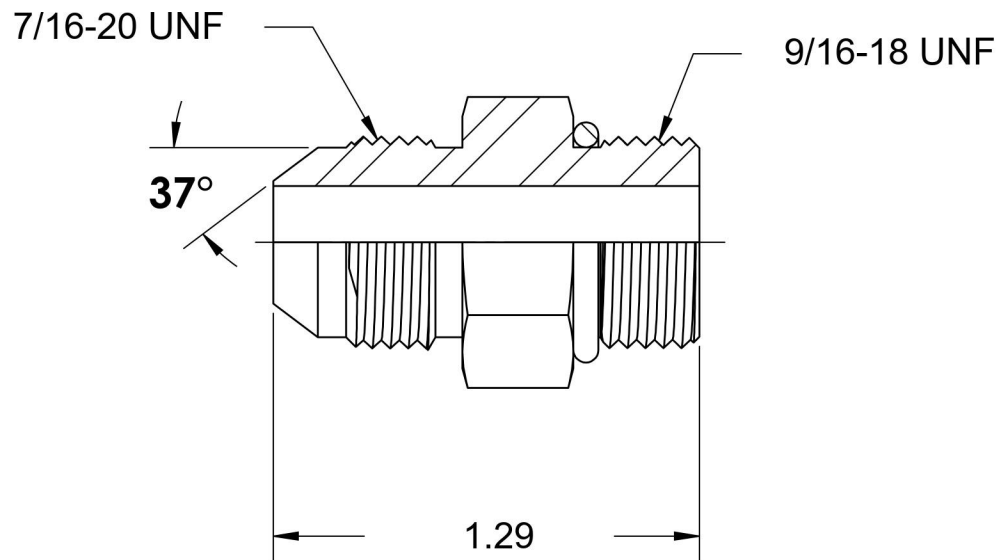
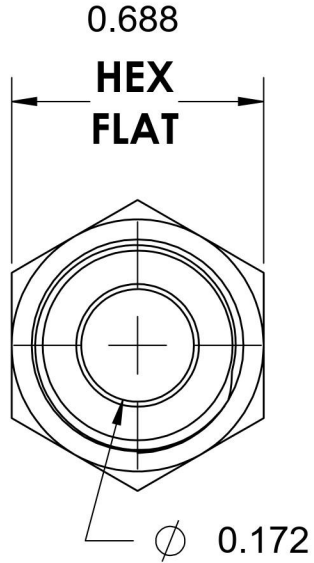

6701 Cochran Road
Solon, Ohio 44139
Phone: (440) 248-1880
Toll Free: 1-888-331-1523

Temperature Rating	Material	Industry Standards	Series
-40°F to 250°F	C1045 / 12L14 Steel	SAE J514, SAE J1926-3 ASTM B633	6400-O
Pressure Rating	Finish		Series Description
6000 psi	Trivalent Zinc		SAE J514 37° Flare Port Connector