

FS2700-LN-06-06-VITON

Steel, SAE J1453 O-Ring Face Seal Bulkhead With Lock Nut, 3/8" Male ORFS x 3/8" Male ORFS, FKM Seal

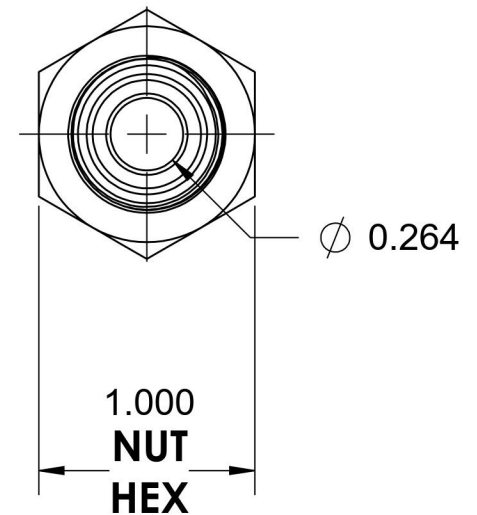
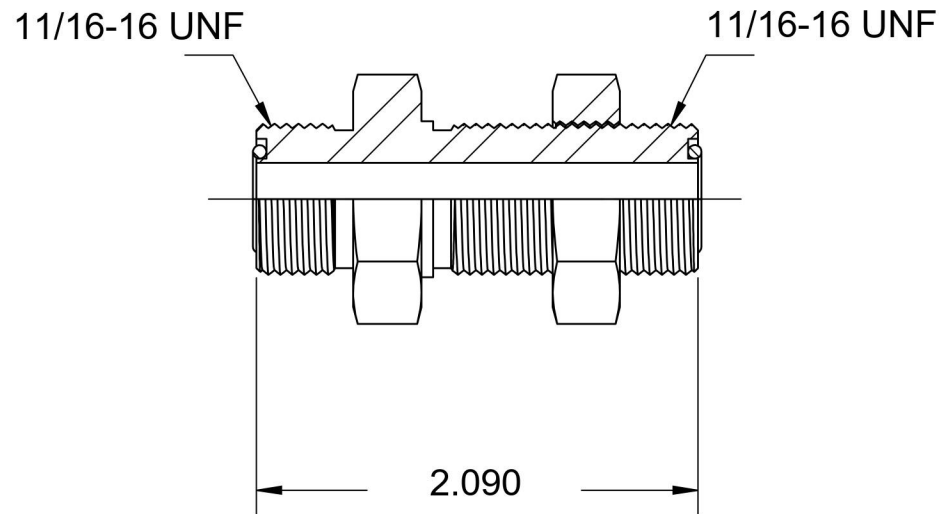
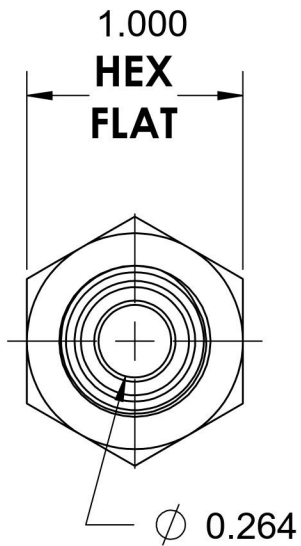
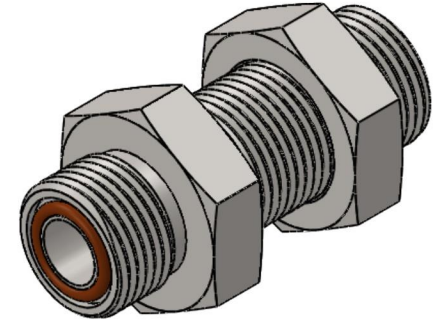

6701 Cochran Road
Solon, Ohio 44139
Phone: (440) 248-1880
Toll Free: 1-888-331-1523

Temperature Rating

-15°F to 400°F

Pressure Rating

9200 psi

Material

C1045/12L14 Steel

Finish

Trivalent Zinc

Industry Standards

SAE J1453, SAE J515
ASTM B633

Series

FS2700-LN-VITON

Series Description

SAE J1453 O-Ring Face Seal
Bulkhead With Lock Nut