

7002-08-06-BS-VITON

Steel, SAE J514 37° Flare BSPP Type (D) Bonded FKM Seal Port/Line Adapter, 1/2" Male JIC x 3/8-19 Male BSPP 60° Line/Port

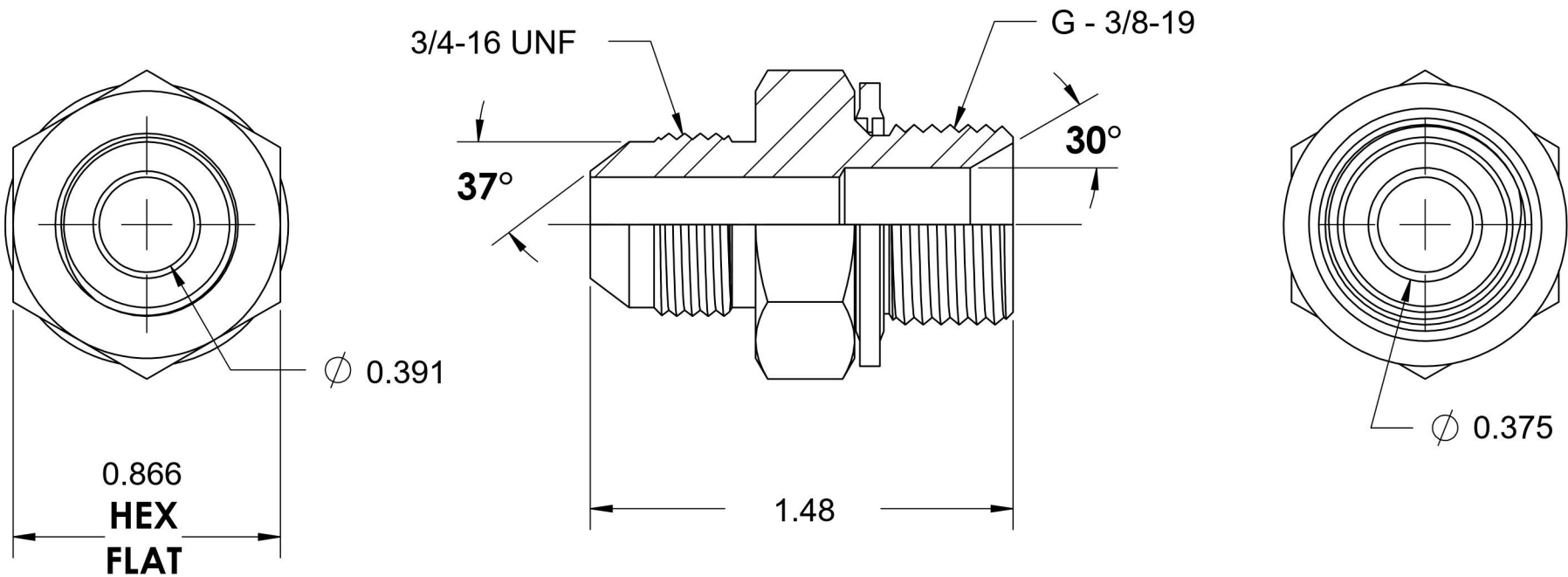

6701 Cochran Road
Solon, Ohio 44139
Phone: (440) 248-1880
Toll Free: 1-888-331-1523

Temperature Rating	Material	Industry Standards	Series
5°F to 500°F	C1045/12L14 Steel	SAE J514, ISO 1179	7002-BS
Pressure Rating	Finish	ASTM B633	Series Description
5100 psi	Trivalent Zinc		SAE J514 37° Flare BSPP Type (D) Bonded Seal Port/Line Adapter