

5500-08-06-SS

Stainless Steel, SAE J514 Pipe 90° Male Elbow, 1/2" Male NPTF 30° x 3/8" Male NPTF 30°

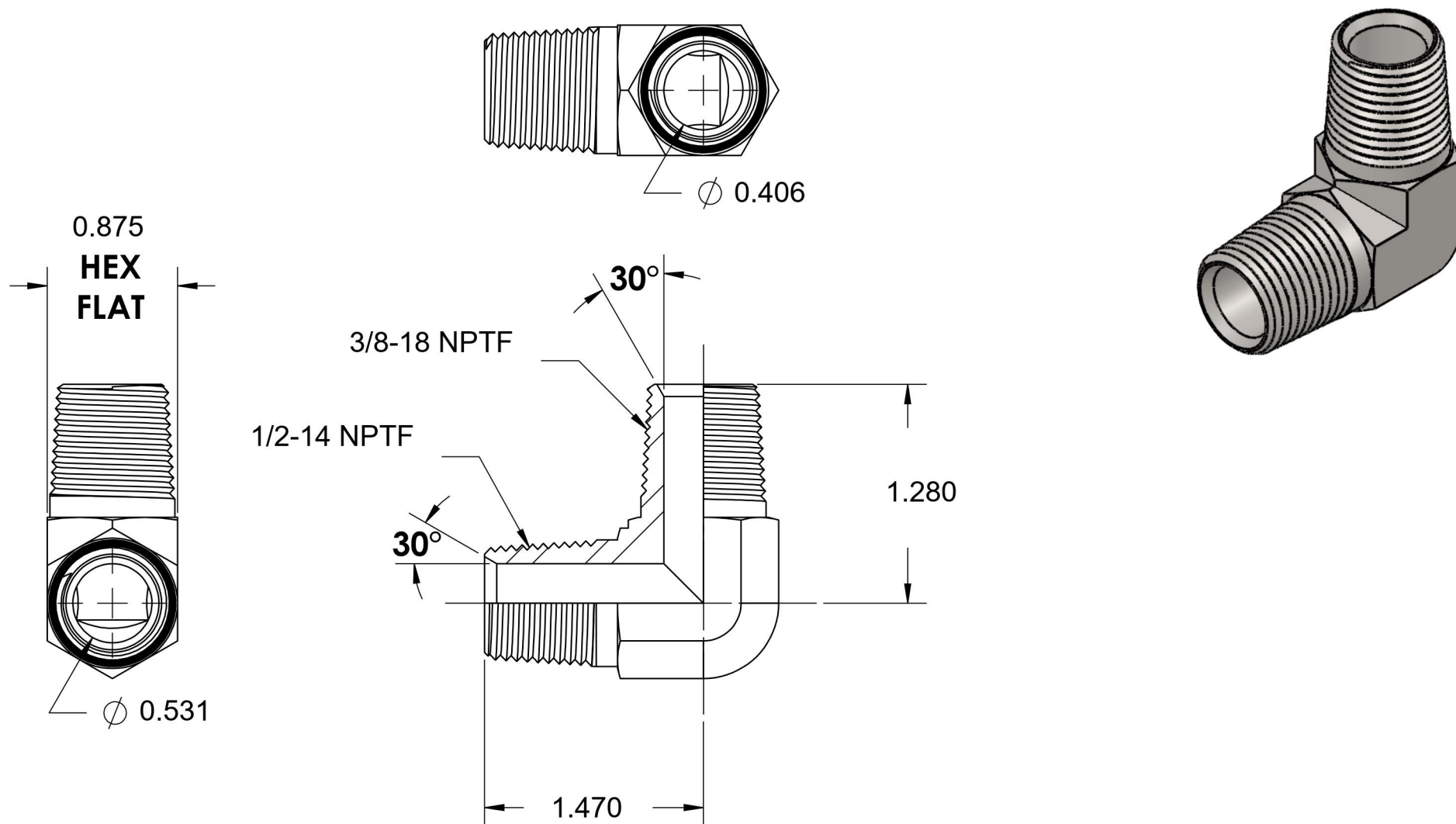

6701 Cochran Road
Solon, Ohio 44139
Phone: (440) 248-1880
Toll Free: 1-888-331-1523

Temperature Rating -425°F to 1200°F	Material 316/316L Stainless Steel	Industry Standards SAE J514 , SAE J476	Series 5500-SS
Pressure Rating 6000 psi	Finish Passivated		Series Description SAE J514 Pipe 90° Male Elbow