

# D0319-06

Steel, DIN 2353 Double Bite Cutting Ring, 6mm Tube OD

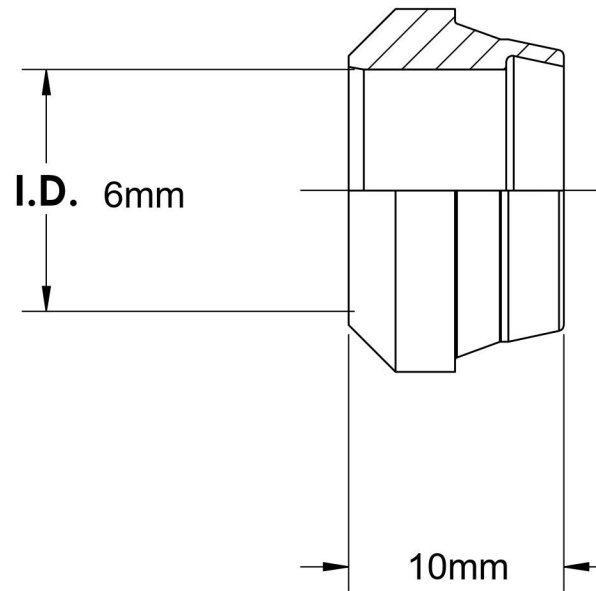
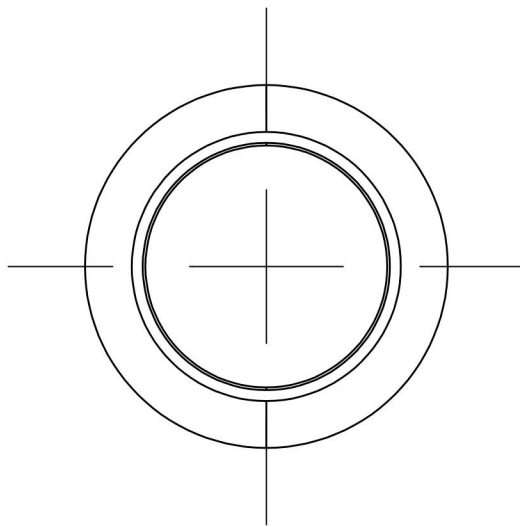
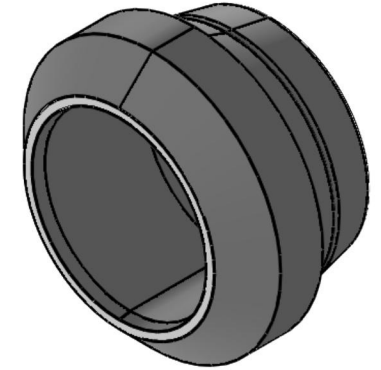

6701 Cochran Road  
Solon, Ohio 44139  
Phone: (440) 248-1880  
Toll Free: 1-888-331-1523

**Temperature Rating**

-65°F to 500°F

**Material**

Carbon Steel

**Industry Standards**

DIN 2353, ISO 8434-1

**Series**

D0319

**Pressure Rating**

11603psi

**Finish**

Zinc Nickel

**Series Description**

DIN 2353 Flareless  
Double Bite Tube Sleeve