

1703-20-24

Steel, SAE J514 37° Flare 45° Code 61 Flange Swept Elbow, 1-1/4" Male JIC x 1-1/2" Split Flange Head

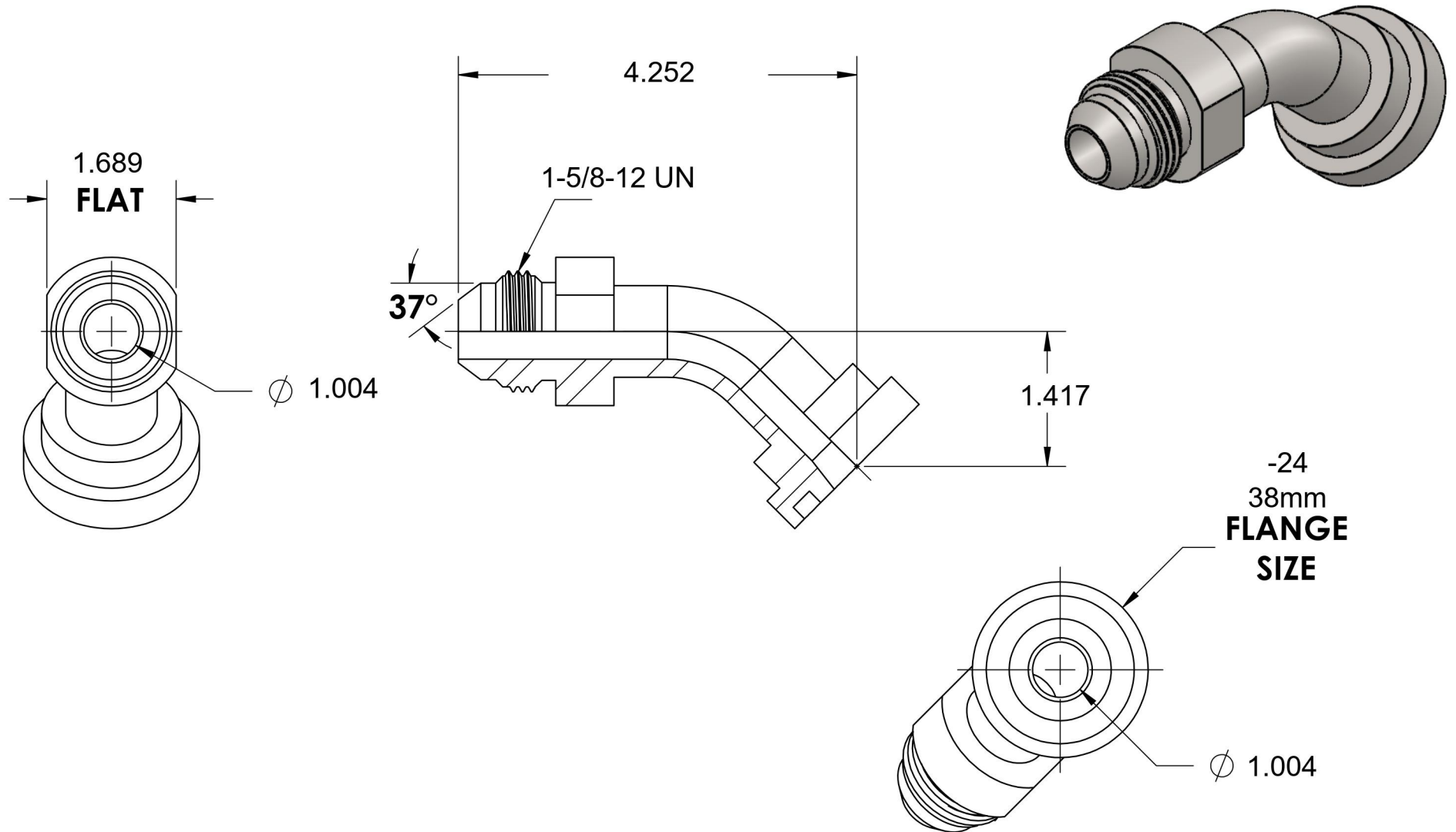

6701 Cochran Road
Solon, Ohio 44139
Phone: (440) 248-1880
Toll Free: 1-888-331-1523

Temperature Rating

-65°F to 500°F

Pressure Rating

3000psi

Material

S20C Steel

Finish

Trivalent Zinc

Industry Standards

SAE J518 Code 61, SAE J514
ASTM B633

Series

1703

Series Description

SAE J514 37° Flare 45° Code 61
Flange Swept Elbow