

# 1704-32-24-FG

Steel, SAE J514 37° Flare 90° Code 61 Flange Forged Elbow, 2" Male JIC x 1-1/2" Split Flange Head

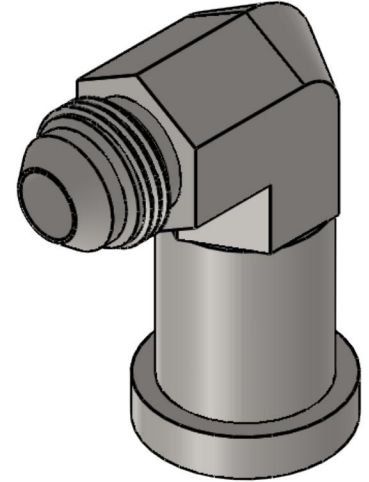
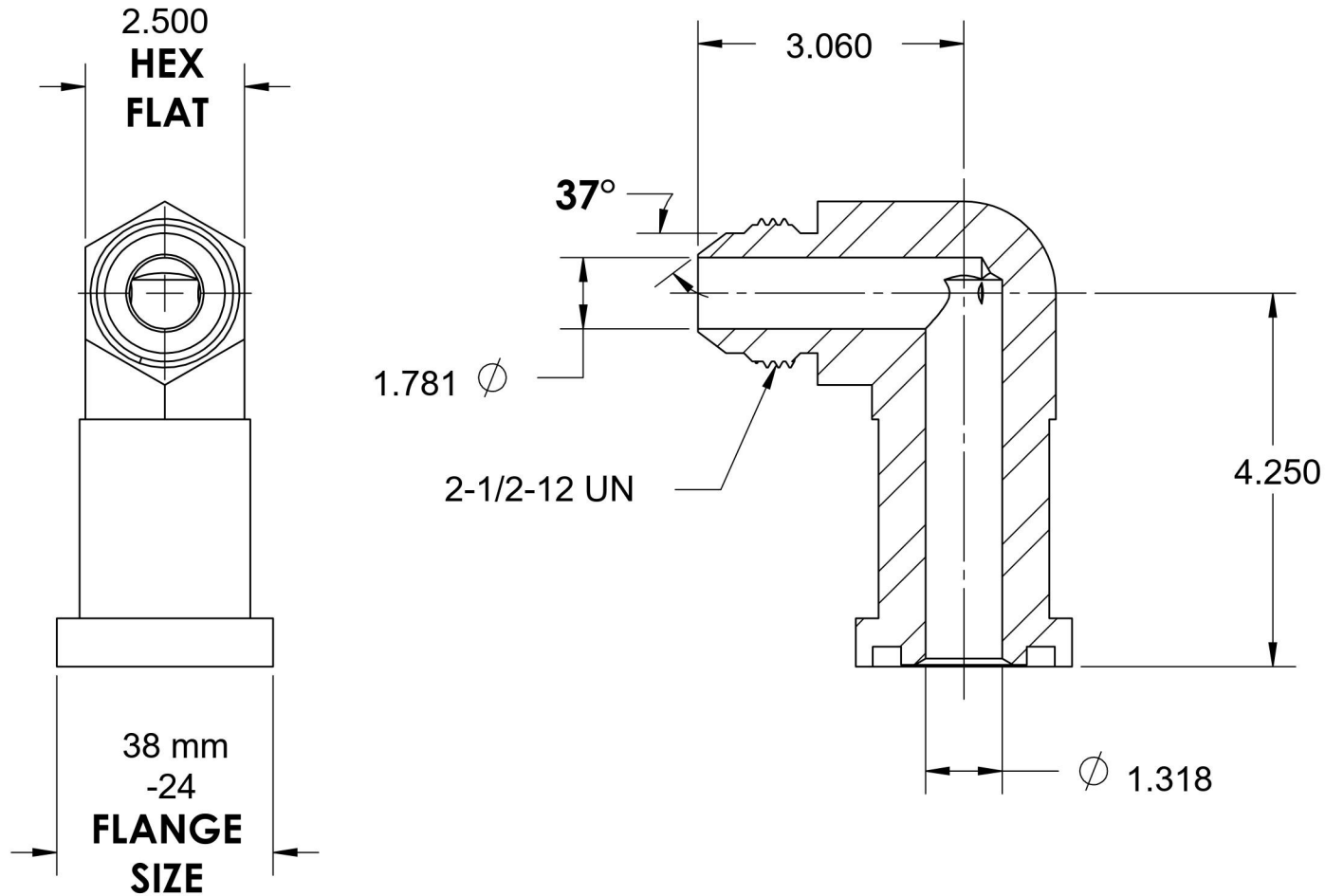

6701 Cochran Road  
Solon, Ohio 44139  
Phone: (440) 248-1880  
Toll Free: 1-888-331-1523

#### Temperature Rating

-65°F to 500°F

#### Pressure Rating

2000psi

#### Material

C1045 Steel

#### Finish

Trivalent Zinc

#### Industry Standards

SAE J518 Code 61  
SAE J514, ASTM B633

#### Series

1704-FG

#### Series Description

SAE J514 37° Flare 90° Code 61  
Flange Forged Elbow