

7007-10-L12-18

Steel, SAE J514 37° Flare DIN (L) Swivel Adapter, 5/8" Male JIC x M18X1.5 Female DKO Swivel

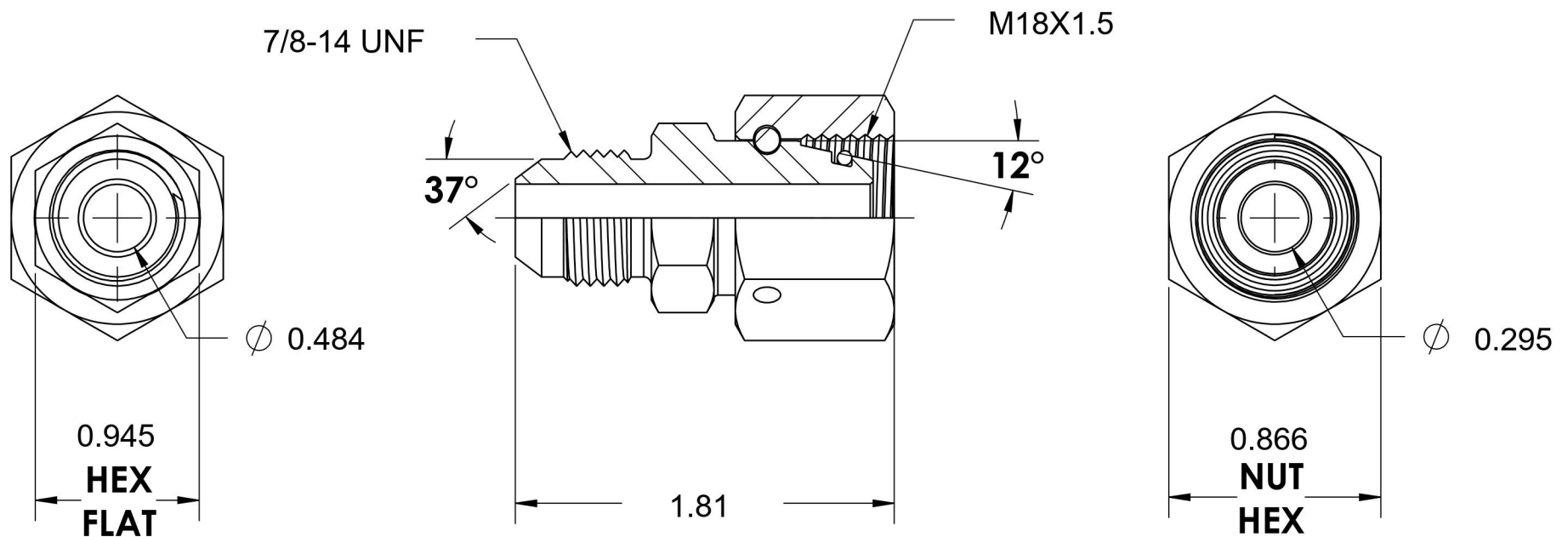

6701 Cochran Road
Solon, Ohio 44139
Phone: (440) 248-1880
Toll Free: 1-888-331-1523

Temperature Rating -40°F to 250°F	Material C1045 / 12L14 Steel	Industry Standards SAE J514, ISO 8434-1 DIN 2353, ASTM B633	Series 7007-DIN LIGHT
Pressure Rating 4500 psi	Finish Trivalent Zinc		Series Description SAE J514 37° Flare DIN (L) Swivel Adapter