

# 0319-12

Steel, SAE J514 37° Flare Tube Sleeve, 3/4" JIC Tube Sleeve

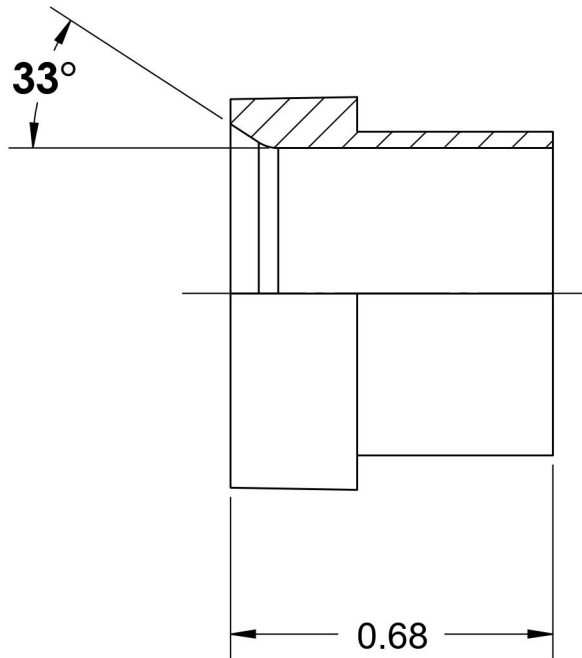
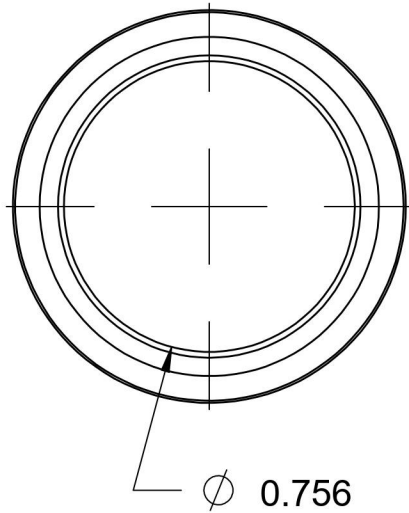

6701 Cochran Road  
Solon, Ohio 44139  
Phone: (440) 248-1880  
Toll Free: 1-888-331-1523

<b>Temperature Rating</b> -65°F to 500°F	<b>Material</b> C1045 / 12L14 Steel	<b>Industry Standards</b> SAE J514, ASTM B633	<b>Series</b> 0319
<b>Pressure Rating</b> Not Applicable	<b>Finish</b> Trivalent Zinc		<b>Series Description</b> SAE J514 37° Flare Tube Sleeve