

FS2700-10-08

Steel, SAE J1453 O-Ring Face Seal Bulkhead, 5/8" Male ORFS x 1/2" Male ORFS

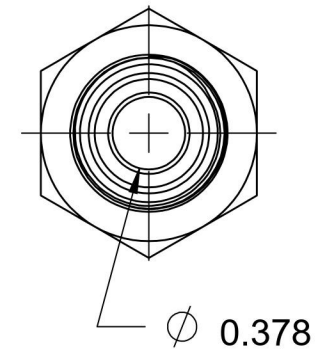
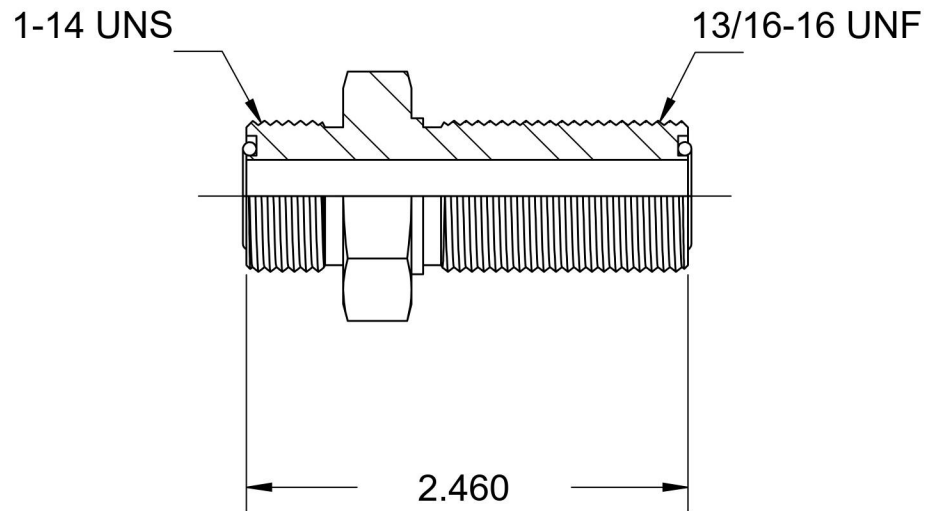
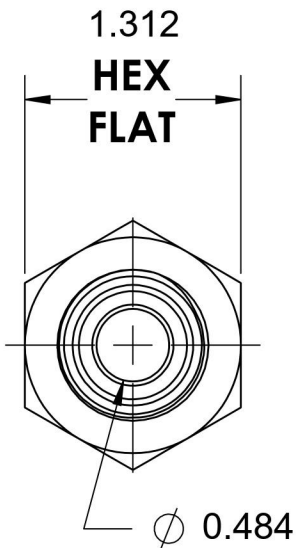
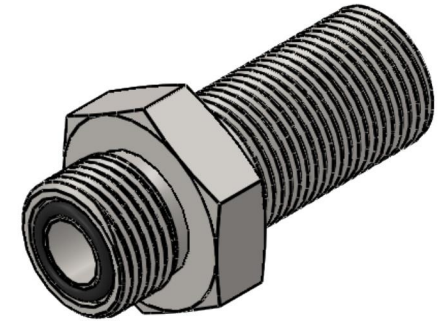

6701 Cochran Road
Solon, Ohio 44139
Phone: (440) 248-1880
Toll Free: 1-888-331-1523

Temperature Rating

-40°F to 250°F

Pressure Rating

6000 psi

Material

C1045/12L14 Steel

Finish

Trivalent Zinc

Industry Standards

SAE J1453, SAE J515
ASTM B633

Series

FS2700

Series Description

SAE J1453 O-Ring Face Seal Bulkhead