

6901-24-24-NWO-SS

Stainless Steel, SAE J514 NPSM Swivel 90° Adjustable Port Elbow, 1-7/8-12 Male Adjustable ORB x 1-1/2" Female NPSM Swivel

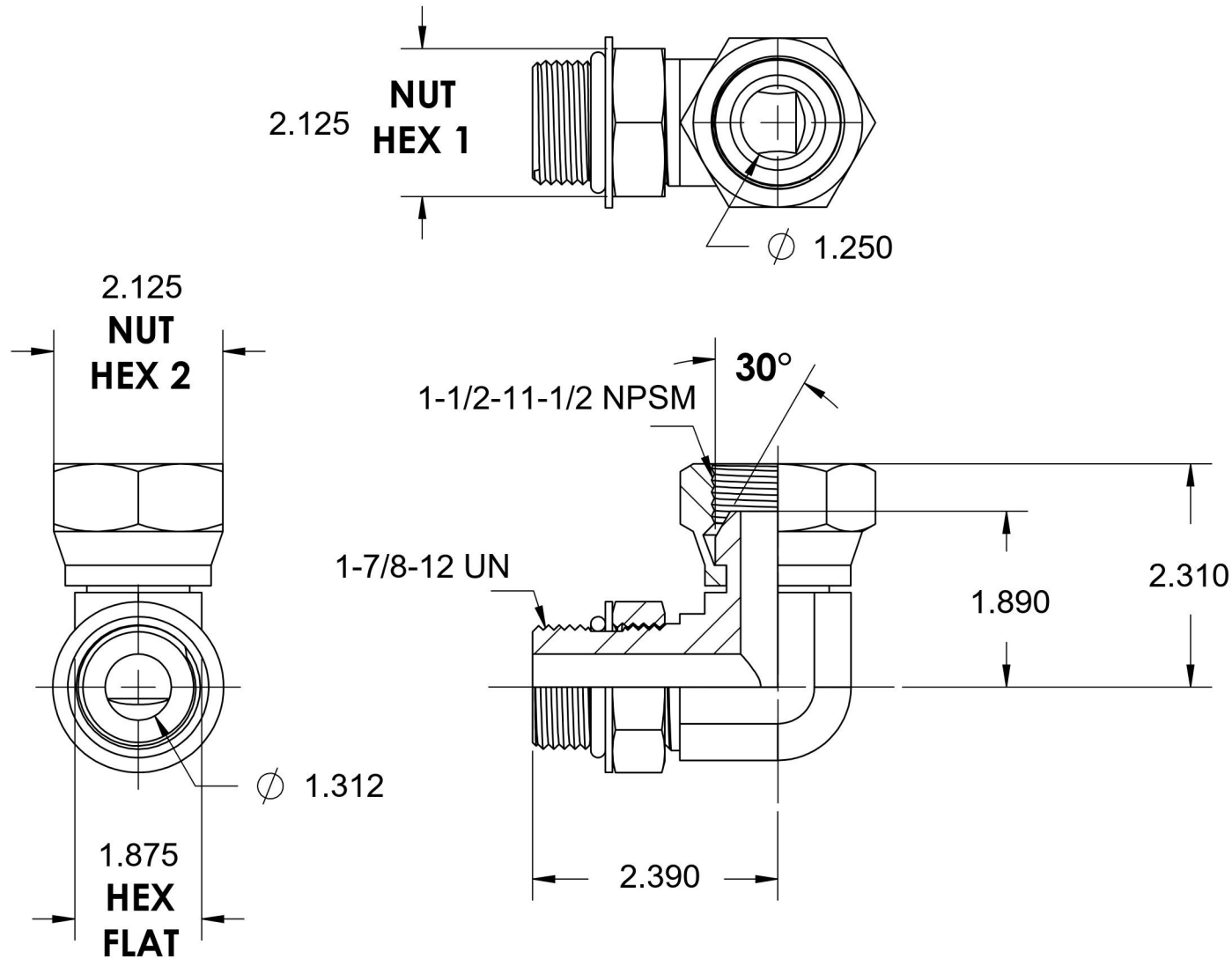

6701 Cochran Road
Solon, Ohio 44139
Phone: (440) 248-1880
Toll Free: 1-888-331-1523

Temperature Rating

-40°F to 250°F

Pressure Rating

1100 psi

Material

316/316L Stainless Steel

Finish

Passivated

Industry Standards

SAE J514, SAE J1926-3
SAE J515

Series

6901-NWO-SS

Series Description

SAE J514 NPSM Swivel 90° Adjustable Port Elbow